

Ubbink Vent Components - Concentric Non-Condensing

- For concentric venting, non-condensing models.
- Concentric venting incorporates a condensate collector and does not require an “adapter” vent component.
- Plastic vent components consist of an outer plastic vent for the air intake and an inner metal vent for the exhaust gases. Metal vent components consist of metal inner and outer vents.
- Plastic and metal vent components are completely interchangeable.

Refer to the Rinnai installation manual and the Ubbink installation instructions for complete installation details and requirements.

Rinnai is continually updating and improving products; therefore, specifications are subject to change without prior notice. Local, state, provincial and federal codes must be adhered to prior to installation.

PLASTIC VENT COMPONENTS

All Weather Termination Kits

(Part No.: STDKITVA-A21)

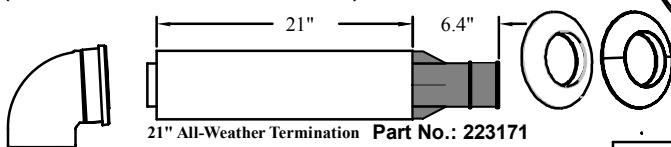

All Components Also Sold Separately

(Part No.: STDKITVA-A)

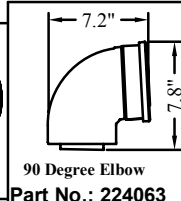
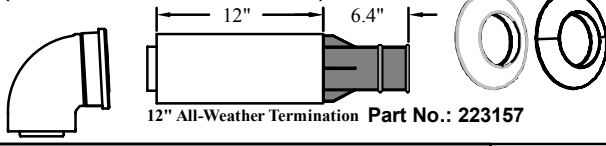

Universal Non-Condensing

(Part No.: 223181)

11.5" Universal Non-Condensing Termination Kit

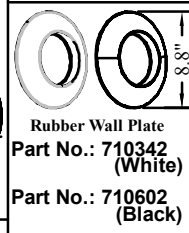
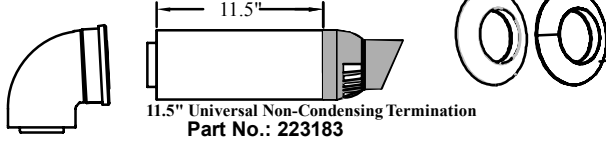

(Part No.: 223182)

21" Universal Non-Condensing Termination Kit

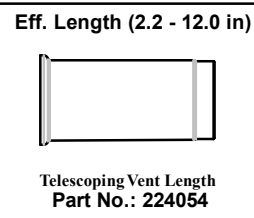
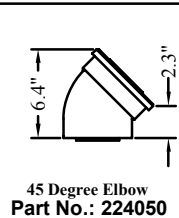
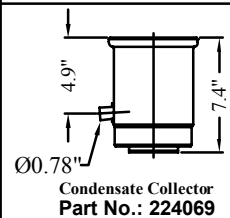
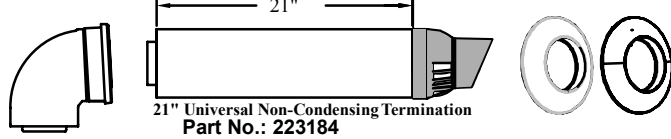

Roof Discharge Termination 18" Part No.: 184118-S

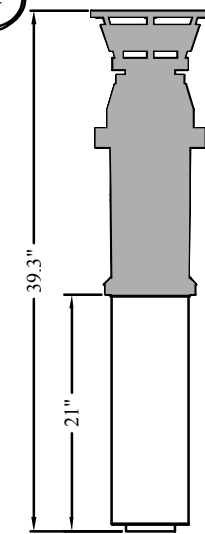

Roof Discharge Termination 38" (Cold Climate) Part No.: 184119

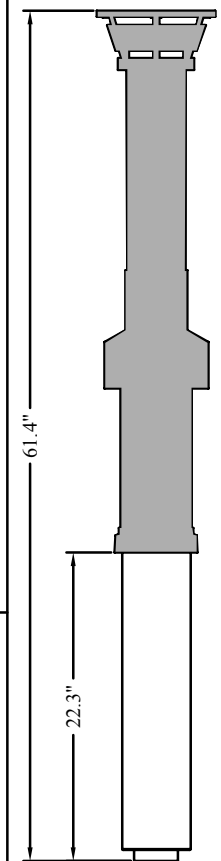

Vent Pipe Extension

Length "L"	Part Number
10"	224051
19.5"	224052
39"	224053

Ubbink Vent Components - Concentric Non-Condensing

METAL VENT COMPONENTS

All-Weather Termination Kit (Metal) (Part No.: 223168)

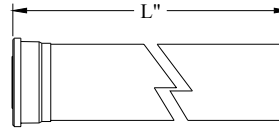
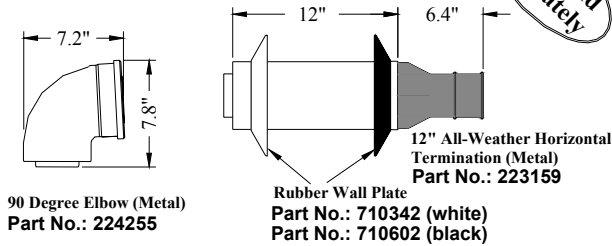

Vent Pipe Extension

Length "L"	Part Number
10"	224260
19.5"	224265
39"	224270

Roof Discharge Termination 18" (Metal) Part No.: 184127

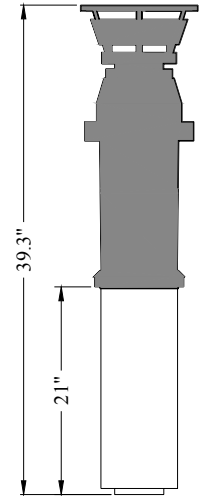

Standard Termination Kit (Metal) (Part No.: 223167)

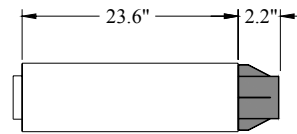
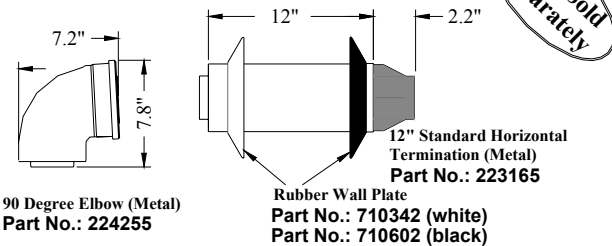

23.6" Standard Horizontal Termination (Metal)
Part No.: 223155

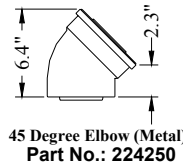

45 Degree Elbow (Metal)
Part No.: 224250

Eff. Length (2.0 - 11.5 in)



Telescoping Vent Length (Metal)
Part No.: 224275

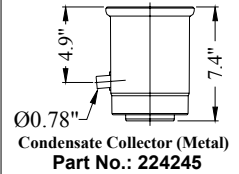

Condensate Collector (Metal)
Part No.: 224245

ACCESSORIES

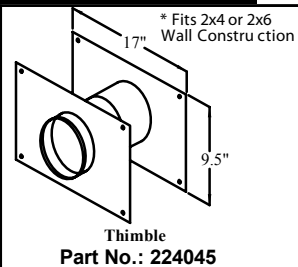

Thimble
Part No.: 224045

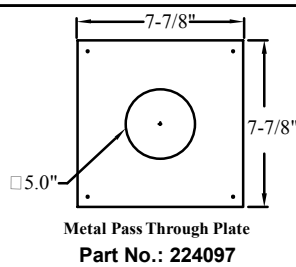

Metal Pass Through Plate
Part No.: 224097

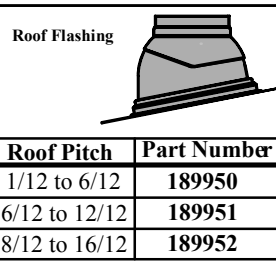

Roof Pitch	Part Number
1/12 to 6/12	189950
6/12 to 12/12	189951
8/12 to 16/12	189952

Raised Horizontal Termination Kit "Snorkel" Part No.: 224046

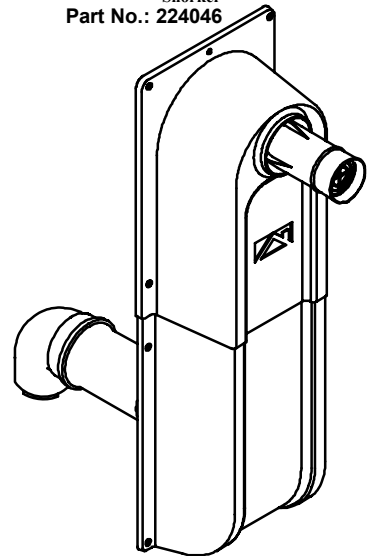

Kit Includes:
14.2" Vent extension, Qty 3 - 90° Elbow, (0224063), Telescoping vent extension (224054) 19.5" Vent pipe extension (224052), Special wall terminal, Cover



Universal Bug Guard
Part No.: 224042

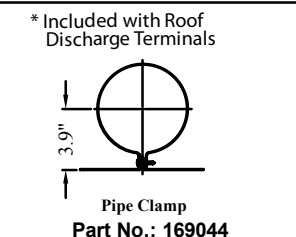

Pipe Clamp
Part No.: 169044

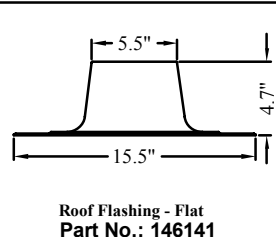

Roof Flashing - Flat
Part No.: 146141

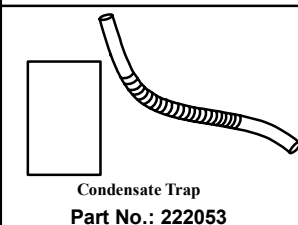

Condensate Trap
Part No.: 222053



NSF Cover
Part No.: 224040

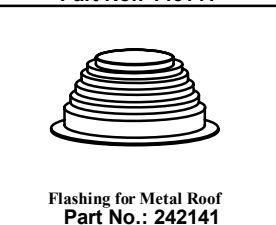

Flashing for Metal Roof
Part No.: 242141