

SOKI 6 SI

Mounting

Connection

Handling

Fault localization

Examples

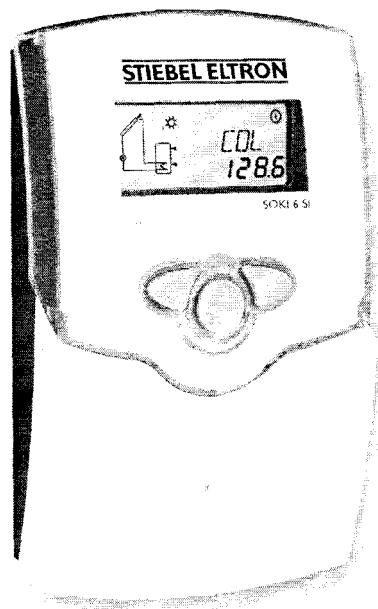

US/CA

manual

Thanks for buying this product.
Read this manual carefully to get the best performance from this unit.

Contents

Imprint	2	2.3	Blinkcodes	7
Security devices	2	2.3.1	System-Screen Blinkcodes	7
Technical data and function survey	3	2.3.2	Blinking codes	7
1. Installation	4	3.	Control parameter and indication channels	8
1.1 Mounting	4	3.1	Channel overview	8
1.2 Electrical wiring	4	3.1.1-6	Indication channels	9
1.2.1 Standard solar system	5	3.1.7-19	Adjustment channels	10
2. Operation and function	6	4.	Tips for fault localization	13
2.1 Adjustment buttons	6	4.1	Miscellaneous	14
2.2 System monitoring display	6			
2.2.1 Channel indication	6			
2.2.2 Tool bar	6			
2.2.3 System screen	7			

Safety regulations:

Please read the following information carefully before installing and operating the controller. In this way damage to the solar system by wrong installation will be avoided. Please observe that the mounting is adapted to the characteristics of the building, that the local regulations are respected and is conform with the technical rules.

DIN 4757, part 1

Solar heating systems with water and water mixtures as heat transfer medium; Demands to the safety realization.

DIN 4757, part 2

Solar heating systems with organic heat transfer medium; Demands to safety realization.

DIN 4757, part 3

Solar heating systems; solar collectors; Meanings; safety regulations; Testing of standstill temperature

DIN 4757, part 4

Solar thermal systems; solar collectors; determination of efficiency; heat capacity and pressure loss.

In addition to that European standards are worked out:

PrEN 12975-1

Thermal solar systems and their components; collectors, part 1: General demands.

PrEN 12975-2

Thermal solar systems and their components; collectors; part 2: Test processes

PrEN 12976-1

Thermal solar systems and their components; prefabricated systems, part 1: General demands.

PrEN 12976-2

Thermal solar systems and their components; prefabricated systems, part 2: Test processes

PrEN 12977-1

Thermal solar systems and their components; Customer-designed manufactured systems, part 1: General demands.

PrEN 12977-2

Thermal solar systems and their components; Customer-designed manufactured systems, part 2: Test processes

PrEN 12977-3

Thermal solar systems and their components; Customer-designed manufactured systems, part 3: Performance test of warm water stores.

Reprinting / copying

This mounting- and operation manual including all parts is copyrighted. Another use outside the copyright requires the approval of STIEBEL-ELTRON Inc. This especially applies for copies, translations, micro films and the storage into electronic systems.

Editor: STIEBEL-ELTRON Inc

Important notice:

We took a lot of care over the texts and drawings of this manual and to the best of our knowledge and consent. As faults can never be excluded, please note:

Your own calculations and plans under consideration of the current norms and DIN-directions should only be basis for your projects. We don't offer a guarantee for the completeness of the drawings and texts of this manual - they only represent some examples. They can only be used on own risk. No liability is assumed for incorrect, incomplete or false information and the resulting damages.

Errors an technical changes excepted.

- system-monitoring-display
- up to 4 temperature sensors Pt1000
- heat balancing
- function control
- user-friendly operation by simple handling
- solar operating hours counter

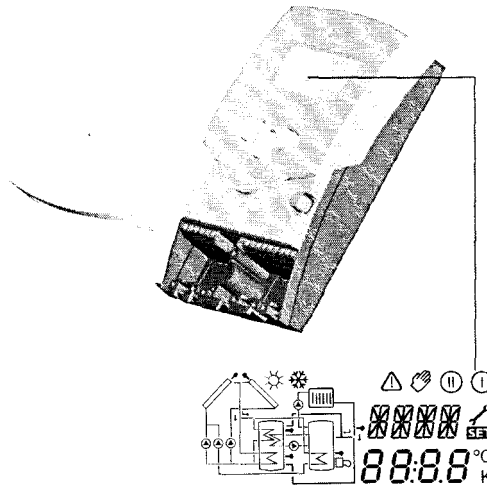

Scope of delivery:

- 1 x SOKI 6 SI
- 1 x accessory bag
 - 1 x spare fuse T4A
 - 2 x screws and dowels
 - 4 x strain relief and screws

Additionally enclosed in the full kit:
2 x sensor FKP6

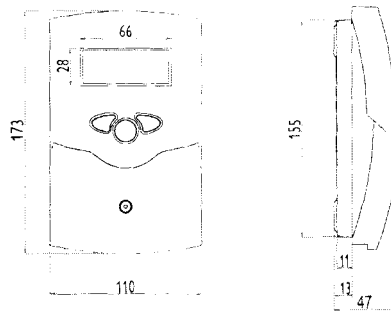

Technical data

Housing:

plastic, PC-ABS and PMMA

Protection type: IP 20 / DIN 40050

Environmental temp.: 0 ... 40 °C

Size: 172 x 110 x 46 mm

Mounting: wall mounting, mounting into patch-panels is possible

Display: System screen for systems visualisation, 16-segment display, 7-segment display, 8 symbols for system status and operating control lamp

Operation: by 3 pushbuttons in the front of the housing

Functions: Temperature differential controller with optional add-on system functions. Function control according to BAW-guidelines, operating hours counter for solar pump, tube collector special function, as well as heat quantity balancing.

Inputs: for 4 temperature sensors Pt1000

Outputs: 1 electromechanical relay

Power supply: 115V~

Total power supply:

2 (1) A 115V~

Mode of operation:

Typ 1.b

Breaking capacity per relay:

electromechanical relay:

2 (1) A 115V~



1. Installation
1.1 Mounting

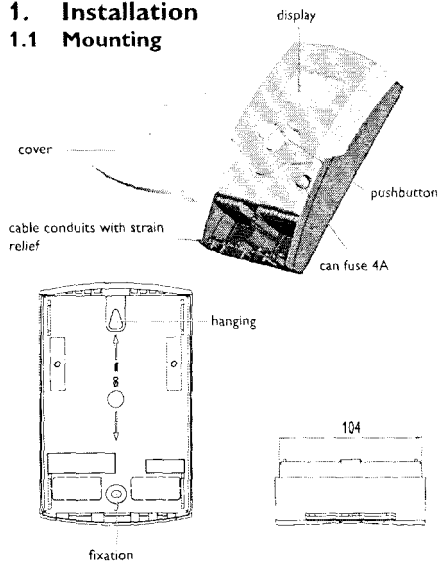

Warning!
Switch-off power supply before opening the housing.

The unit must only be located internally. It is not suitable for installation in hazardous locations and should not be sited near to any electromagnetic field. The controller must additionally be equipped with an all-polar gap of at least 3 mm or with a gap according to the valid installation regulations, e.g. LS-switches or fuses. Please pay attention to a separate laying of the cable lines and installation of ac power supply.

1. Unscrew the cross-recessed screw of the cover and remove it from the housing.
2. Mark the upper fastening point on the wall and pre-mount the enclosed dowel and screw.
3. Hang up the housing at the upper fastening point and mark the lower fastening point on the underground (hole pitch 130 mm), afterwards put the lower dowel.
4. Fasten the housing at the underground.

1.2 Electrical wiring

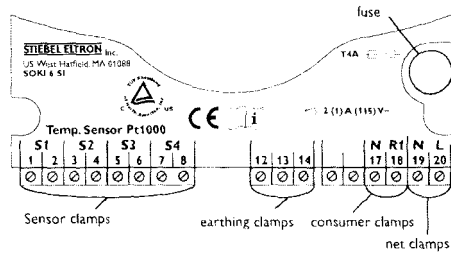

The power supply to the controller must only be made by an external power supply switch (last step of installation!) and the line voltage must be 115 Volt (50...60 Hz). Flexible lines are to be fixed at the housing by enclosed strain relief supports and screws.

Depending on the version the controller is equipped with 1 relay to which the **consumers** e.g. pumps, valves etc. can be connected:

- Relay 1
 - 18 = conductor R1
 - 17 = neutral conductor N
 - 13 = ground clamp ⊕

The **temperature sensors** (S1 up to S4) will be connected to the following terminals independently of the polarity:

- 1 / 2 = Sensor 1 (e.g. Sensor collector 1)
- 3 / 4 = Sensor 2 (e.g. Sensor store 1)
- 5 / 6 = Sensor 3 (e.g. Sensor TSPU)
- 7 / 8 = Sensor 4 (e.g. Sensor TRF)

The **power supply** is effected to the clamps:

- 19 = neutral conductor N
- 20 = conductor L
- 12 = ground clamp ⊕



Electrostatic discharge can lead to damages of electronic components!



Dangerous voltage on contact!

1.2.1 Allocation of clamps for system 1

Standard solar system with 1 store, 1 pump and 3 sensors. The sensor S4 / TRF can optionally be used for heat quantity balancing.

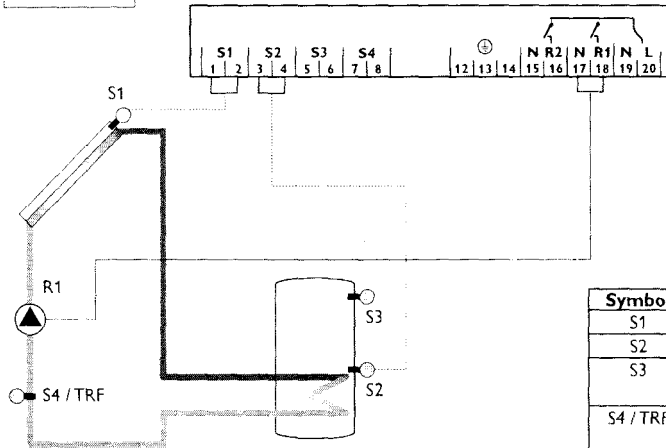
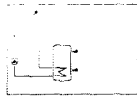

Symbol	Specification
S1	Collector sensor
S2	Store sensor below
S3	Store sensor at the top (optionally)
S4 / TRF	Sensor for heat quantity measurement (optionally)
R1	Solar pump

2. Operation and function
2.1 Pushbuttons for adjustment

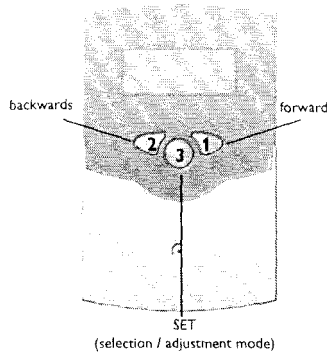

The controller is operated by 3 pushbuttons below the display. The forward-key (1) is used for scrolling forward through the indication menu or to increase the adjustment values. The backwards-key (2) is accordingly used for the reverse function.

For adjustment of last indication channel, keep button 1 pressed for 2 seconds. If an **adjustment value** is shown on the display, **SEt** is indicated. In this case you can press the key „Set“ (3) in order to change into input mode.

- Select a channel by keys 1 and 2
- Shortly press key 3, so that „SEt“ flashes
- Adjust the value by keys 1 and 2
- Shortly press key 3, so that „SEt“ permanently appears, the adjusted value is now saved.

2.2 System monitoring display

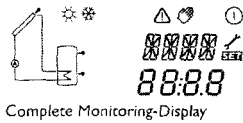

The system monitoring display consists of 3 blocks: **indication of the channel**, **tool bar** and **system screen** (active system scheme).

2.2.1 Channel indication



The **indication channel** consists of two lines. The upper line is an alphanumeric 16-segment indication, in which mainly the channel names / menu items are shown. In the lower 7-segment indication, the channel values and the adjustment parameter are indicated. Temperatures and temperature differences are indicated in °F or °Ra.

2.2.2 Tool bar



The additional symbols of the **tool bar** indicate the current system status.

Symbol	standard	flashing
①	relay 1 active	
☀	maximum store limitation active / maximum store temperature exceeded	collector cooling function or recolling function active
❄	antifreeze- function activated	collector minimum limitation or antifreeze function active
⚠		collector security shutdown or store security shutdown active
⚠ + 🔧		sensor defect
⚠ + 🖱		manual operation active
SEt		an adjustment channel is changed SEt-mode

2.2.3 System screen



only system screen

The system screen (active system scheme) shows the schemes selected on the controller. It consists of several system component symbols, which are - depending on the current status of the system - either flashing, permanently shown or hidden.

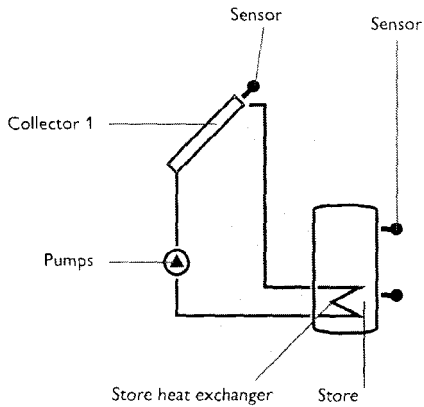

Collector
with collector sensor



Store 1
with heat exchanger



Temperature sensor



Pump

2.3 Blinking codes

2.3.1 System screen blinking codes

- Pumps are blinking during starting phase
- Sensors are blinking if the respective sensor-indication channel is selected.
- Sensors are quickly blinking in case of sensor defect.
- Burner symbol is blinking if after-heating is activated.

2.3.2 LED blinking codes

- Constantly green: everything all right
- Red/green blinking: initialisation phase
manual operation
- Red blinking: sensor defect
(sensor symbol is quickly blinking)

3. Controller parameter and indication channels

3.1 Channel-overview

Legend:



Corresponding channel is available if the appropriate option is activated.

Please note:

S3 and S4 are only indicated if sensors are connected.



Corresponding channel is only available if the option heat quantity measurement is **activated** (OWMZ).



Corresponding channel is only available if the option heat quantity measurement is **deactivated** (OWMZ).

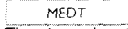

The channel antifreeze content (MED%) is only shown if a medium other than **water or Tyfocor LS / G-LS (MEDT 0 or 3)** is used. The adjustment is only appropriate when using other types of antifreeze.

channel		specification	page
COL	x	Temperature collector 1	9
TST	x	Temperature store 1	9
S3	x	Temperature sensor 3	9
TRF	①	Temperature return sensor	9
S4	②	Temperature sensor 4	9
h P	x	Operating hours relay 1	9
kWh	①	Heat quantity kWh	10
MWh	①	Heat quantity MWh	10
DT O	x	Switch-on temperature difference	10
DT F	x	Switch-off temperature difference	10
S MX	x	Maximum temperature store 1	11
EM	x	emergency temperature collector 1	11

channel		specification	page
OCN	x	Option minimum limitation collector 1	11
CMN	x*	Minimum temperature collector 1	11
OCF	x	Option antifreeze collector 1	11
CFR	x ²	Antifreeze temperature collector 1	11
OREC	x	Option recirculating	12
OTC	x	Option tube collector	12
OHQM	x	Option WMZ	12
FMAX	①	Maximum flow	10
MEDT	①	Antifreeze type	10
MED%	MEDT	Antifreeze content	10
HND	x	Manual operation relay 1	12
LANG	x	Language	12
UNIT	x	Change over °FAH / °CEL	12
PROG	XX.XX	Program number	
VERS	X.XX	Version number	

3.1.1 Indication of collector temperatures

COL:

Collector temperature
display range: -40...+482 °F



COL
128.6

Shows the current collector temperature.

- COL : collector temperature (1-collector-system)

3.1.2 Indication of store temperatures

TST:

Store temperatures
Display range: -40...+482 °F



TST
110.6

Shows the current store temperature.

- TST : store temperature (1-store-system)

3.1.3 Indication of sensor 3 and sensor 4

S3, S4:

Sensor temperatures
Display range: -40...+482 °F



S3
S4
83.6

Shows the current temperature of the corresponding additional sensor (without control function).

- S3 : temperature sensor 3
- S4 : temperature sensor 4

Please note:

S3 and S4 are only indicated if the temperature sensors are connected (shown).

3.1.4 Indication of other temperatures

TRF:

other measured
temperatures
Display range: -40...+482 °F



TRF
91.2

Shows the current temperature of the sensor.

- TRF : temperature return flow

3.1.5 Operating hours counter

h P:

Operating hours counter
Display channel



h P
305

The operating hours counter adds up the solar operating hours of the respective relay (**h P**). Full hours are shown on the display.

The operating hours added up can be reset. As soon as one operating hours channel is selected, the symbol **h P** is permanently shown on the display. The button SET (3) must be pressed for approx. 2 seconds in order to get back into the RESET-mode of the counter. The display-symbol **h P** is flashing and the operating hours will be set to 0. In order to finish the RESET-procedure, the button **h P** must be pressed in order to confirm.

In order to interrupt the RESET-procedure, no button should be pressed for about 5 seconds. The controller returns automatically into the indicator mode.

3.1.6 Heat quantity balancing

OHQM:Heat quantity balancing

Adjustment range: OFF...ON
Factory setting: OFF



FMAX:

Volume flow in l/min
Adjustment range 0 ... 20
in steps of 0.1
Factory setting 6.0



MEDT: Type of antifreeze
Adjustment range 0 ... 3
Factory setting 1

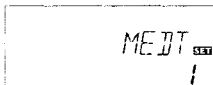

MED%: Concentration of antifreeze in (Vol-) %
MED% is blinded out by MEDT 0 and 3.
Adjustment range 20 ... 70
Factory setting 45

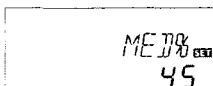

kWh/MWh:Heat quantity in kWh / MWh
Display channel

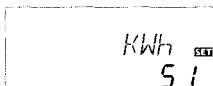

A heat quantity balancing is possible for all systems in conjunction with a flowmeter. You just have to activate the option heat quantity balancing in the channel **OHQM**.

The volume flow readable at the flowmeter (l/min) must be adjusted in the channel **FMAX**. Antifreeze type and concentration of the heat transfer medium are indicated on the channels **MEDT** and **MED%**.

Type of antifreeze:

- 0 : water
- 1 : propylene glycol
- 2 : ethylene glycol
- 3 : Tyfocor® LS / G-LS

The heat quantity transported is measured by the indication of the volume flow and the reference sensor of feed flow S1 and return flow S4. It is shown in kWh-parts in the indication channel **kWh** and in MWh-parts in the indication channel **MWh**. The sum of both channels form the total heat output.

The heat quantity added up can be reset. As soon as one of the display channels of the heat quantity is selected, the symbol **SET** is permanently shown on the display. The button SET (3) must be pressed for approx. 2 seconds in order to get back into the RESET-mode of the counter. The display-symbol **SET** is flashing and the value for heat quantity will be set to 0. In order to finish the RESET-procedure, the button **SET** must be pressed for confirmation.

In order to interrupt the RESET-procedure, no button should be pressed for about 5 seconds. The controller returns automatically into indication mode.

3.1.7 ΔT-regulation

DT O:

Switch-on temperature
Adjustment range
2.0 ... 40.0 °Ra
Factory setting 12.0

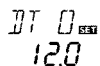

DT F:

Switch-off temperature diff.
Adjustment range
1.0 ... 38 °Ra
Factory setting 8.0 °Ra

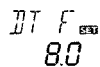

Please note: Switch-on temperature difference DO must be at least 2 °Ra higher than the switch-off temperature-difference DF.

Primarily the controller works in the same way as a standard differential controller. If the switch-on difference (**DT O**) is reached, the pump is activated. If the adjusted switch-off temperature is underrun (**DT F**), the controller switches-off.

3.1.8 Maximum store temperature

S MX:

Maximum store temp.
Adjustment range
40 ... 205 °F
Factory setting 140 °F

S MX SET
140

If the adjusted maximum temperature is exceeded, a further loading of the store is stopped so that a damaging overheating can be avoided. If the maximum store temperature is exceeded, on the display is shown and ●.

Please note: The controller is equipped with a security-switch-off of the store, which avoids a further loading of the store if 203 °F are reached at the store.

3.1.9 Limit collector temperature Collector emergency shutdown

EM:

Limit collector temperature
Adjustment range
230 ... 400 °F
Factory setting 285 °F

EM SET
285

If the adjusted collector limit temperature (**EM**) is exceeded, the solar pump (R1/R2) is deactivated in order to avoid a damaging overheating of the solar components (collector emergency shutdown). The limit temperature is set to 285 °F but it can be changed within the adjustment range of 230 ... 400 °F. In the display is shown △ (flashing).

3.1.10 System cooling

OCX:

Option system cooling
Adjustment OFF ... ON
Factory setting OFF

OCX SET
OFF

CMX:

Maximum collector temp.
Adjustment range
210 ... 380 °F
Factory setting 250 °F

CMX SET
250

If the adjusted maximum store temperature is reached, the solar system switches-off. If now the collector temperature raises to the adjusted maximum collector temperature (**CMX**), the solar pump remains activated until this limit temperature value is again underrun. The store temperature might continue to raise (subordinated active maximum store temperature), but only until 203 °F (emergency shutdown of the store). If the store temperature is higher than the maximum store temperature (**SMX**) and the collector temperature is lower by at least 5 K than the store temperature, the solar system remains activated until the store is again cooled down by the collector and the tubes under the adjusted maximum temperature (**S MX**).

In case of active system cooling on the display is shown ● (flashing). Due to the cooling function the solar system can be kept operable for a longer period on hot summer days and a thermal release of the collector and the heat transfer medium is ensured as well.

3.1.11 Option minimum collector limitation

OCN:

Minimum collector limitation
Adjustment range OFF / ON
Factory setting OFF

OCN SET
OFF

CMN:

Minimum collector temperature
Adjustment range
-10 ... 90 °C
Factory setting 10 °C

CMN SET
50.0

The minimum collector temperature is a minimum switching temperature, which must be exceeded so that the solar pump (R1/R2) is switched-on. The minimum temperature shall avoid a steady starting-up of the solar pump (or solid fuel boiler charging pumps) for low collector temperatures. If the minimum temperature is underrun, in the display is shown ❄ (flashing).

3.1.12 Option antifreeze function

OCF:

Antifreeze function
Adjustment range
OFF / ON
Factory setting OFF

OCF SET
OFF

CFR:

Antifreeze temperature
Adjustment range
-10 ... 10 °C
Factory setting 4.0 °C

CFR SET
4.0

The antifreeze function activates the loading circuit between collector and store if the adjusted antifreeze function is underrun in order to protect the medium that it will not freeze or „get thick“. If the adjusted antifreeze temperature is exceeded by 2 °F, the loading circuit will be deactivated.

Please note:

As there is only a limited heat quantity of the store available for this function, the antifreeze function should only be used in regions with few days of temperatures around freezing point.

3.1.13 Recooling function

OREC:

option recooling
adjustment range
OFF...ON
Factory setting: OFF

If the adjusted maximum store temperature (**S MX**) is reached, the solar pump remains activated in order to avoid an overheating of the collector. The store temperature might continue to increase but only up to 203 °F (emergency shutdown of the store). In the evening the solar system continues running until the store is cooled down to the adjusted maximum store temperature via collector and pipes.

3.1.14 Tube collector special function

OTC:

Tube collector special
function
Adjustment range:
OFF...ON
Factory setting: OFF

If the controller measures an increase of 4 °Ra compared to the collector temperature stored at last, the solar pump is switched-on to 100 % for about 30 seconds. After expiration of the solar pump runtime the current collector temperature is stored as new reference value. If the measured temperature (new reference value) is again exceeded by 4 °Ra, the solar pump again switches-on for 30 seconds. If the switch-on difference between collector and store is again exceeded during runtime of the solar pump or the standstill of the system, the controller automatically switches over to solar charging. If the collector temperature drops by 4 °Ra during standstill, the switch-on value for the special tube collector function will be recalculated.

3.1.15 Operating mode

HAND:

Operating mode
Adjustment range:
OFF,AUTO,ON
Factory setting:AUTO

For control and service work the operating mode of the controller can be manually adjusted by selecting the adjustment value **HAND**, in which the following adjustments can be made:

- **HAND**
Operating mode
- OFF : relay off (flashing) +
- AUTO : relay in automatic operation
- ON : relay on (flashing) +

3.1.16 Language

LANG:

Adjustment of language
Adjustment range: dE, En, It
Factory setting: En

The menu language can be adjusted in this channel.

- dE : German
- En : English
- It : Italiano
- Fr : French

3.1.17 Unit

UNIT:

Adjustment of unit
Adjustment range: FAH, °C
Factory setting: FAH



The menu unit can be adjusted:

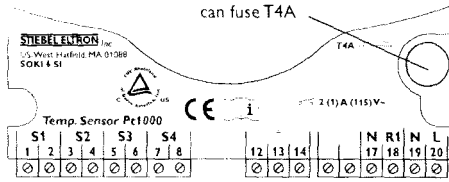

- °FAH
- °CEL

4. Tips for fault localization

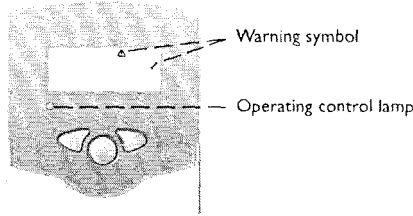

If a malfunction occurs, a notification is given on the display of the controller:



Operating control lamp flashes red. On the display appears the symbol  and the symbol .

Operating control lamp off

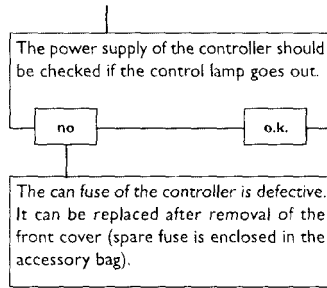
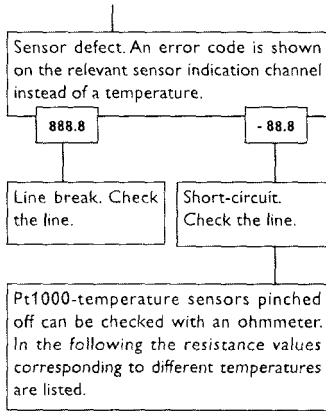

°F	Ω	°F	Ω
14	961	131	1213
23	980	140	1232
32	1000	149	1252
41	1019	158	1271
50	1039	167	1290
59	1058	176	1309
68	1078	185	1328
77	1097	194	1347
86	1117	203	1366
95	1136	212	1385
104	1155	221	1404
113	1175	230	1423
122	1194	239	1442

Resistance values of the Pt1000-sensors

4.1 Various:

Pump is overheated, but no heat transfer from collector to the store, feed flow and return flow are equally warm, perhaps also bubble in the lines.

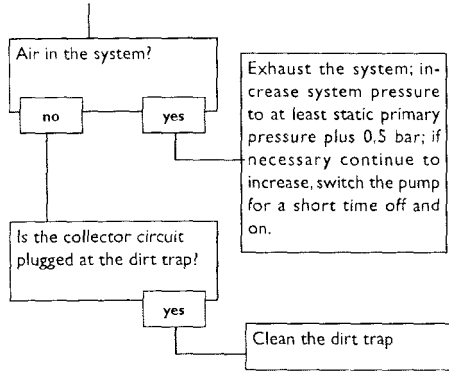

Pump starts for a short moment, switches-off, switches-on again, etc. („controller hunting“)

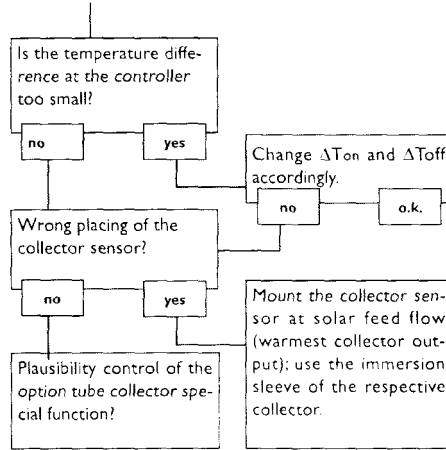

Pump starts up very late and soon stops working soon.

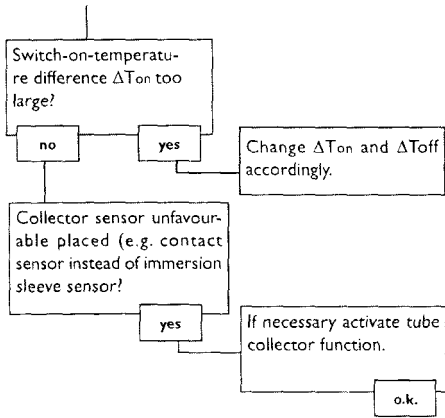

The temperature difference between store and collector increases enormously during operation; the collector circuit cannot dissipate the heat.

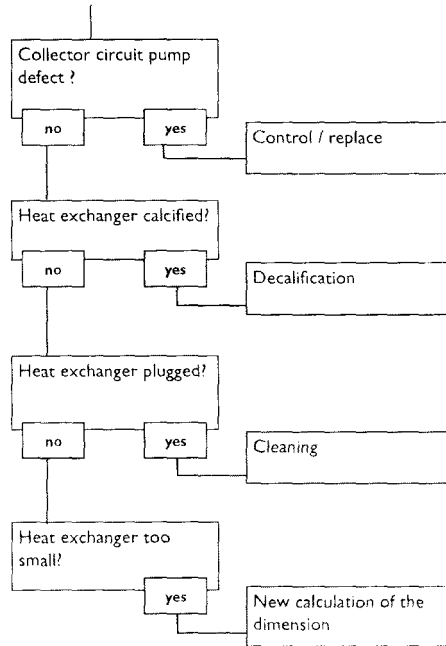

Stores are cooled during the night.

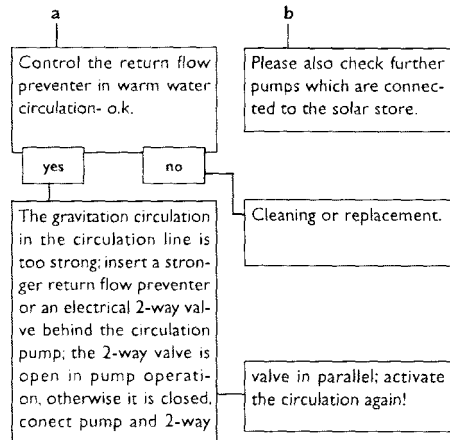
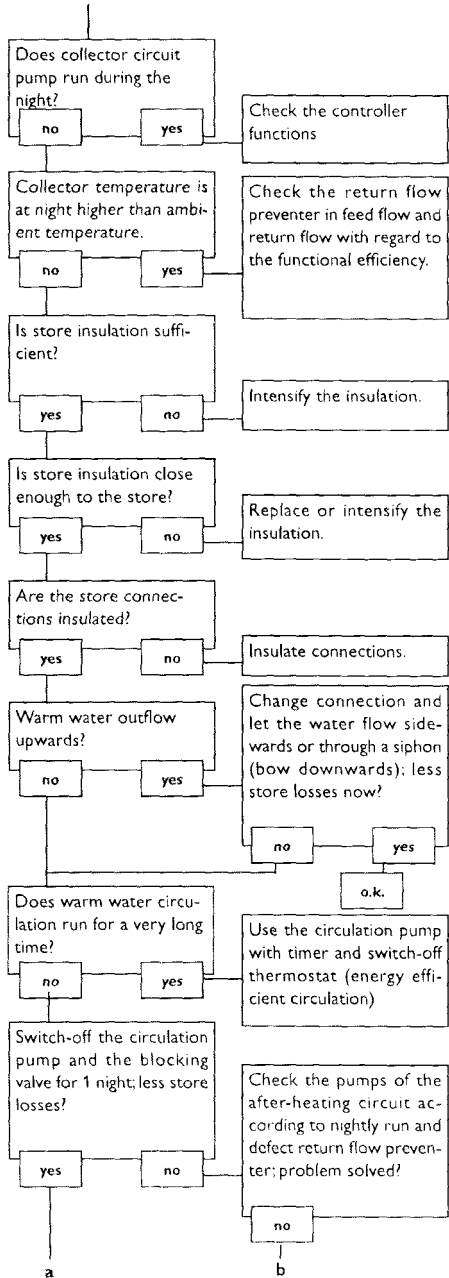

The solar circuit pump does not work although the collector is obviously warmer than the store.

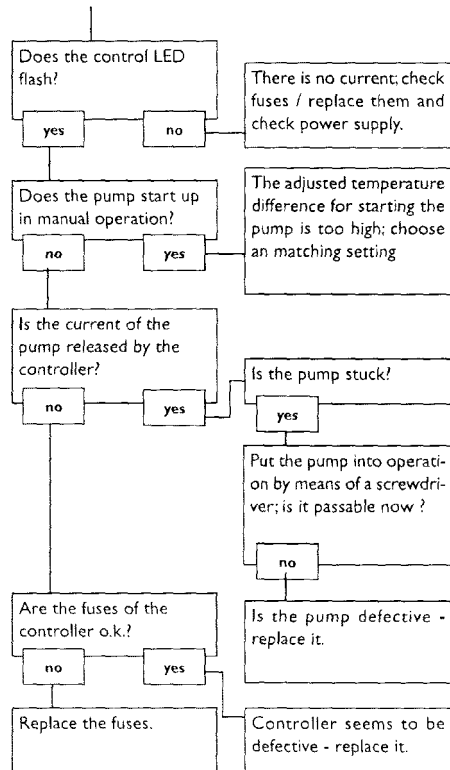

SOKI 6 SI

STIEBEL ELTRON

Stiebel Eltron, Inc.

17 West Street
USA - West Hatfield, MA 01088
Phone: (413) 247-3380
Fax: (413) 247-3369
info@stiebel-eltron-usa.com

Distributed by:

Please note:

The design and the specifications are to be changed without notice.
The illustrations may differ from original product.