

# Electric Mini-Boiler<sup>TM</sup>

## Installation & Operating Instructions

Model EMB-W-9    9 kW    2 GPM minimum flow

**Application** - Low temperature, low pressure, radiant underfloor heating systems. This model includes a factory installed WarmFlo<sup>®</sup> aquastat.

**Comment** - If this application is for traditional hydronics heating requiring temperatures greater than 140° and capacities larger than shown above, contact factory for other Electro-Boiler product series.

If this application requires temperatures greater than 140°, this is the wrong model. Contact the distributor or factory for the EB-M\*-\*\* model series which is designed for temperatures up to 180°. This series can also do outdoor reset and other features.

**Accessories** – Attached BL001 lists various accessory or option items which are not part of basic Electro-Boiler. Page 1 gives information on a zone control update which stages elements based upon zone capacity.

**Note:** This product meets the requirements of the ASME Boiler and Pressure Vessel Code.

Drawings:    **BX304**  
                  **BH304**  
                  **BS304**  
                  **BS309**  
                  **BD705**  
                  **BH007**  
                  **BL001**



**ELECTRO INDUSTRIES, INC.**  
2150 West River Street, PO Box 538, Monticello, MN 55362  
763.295.4138 • 800.922.4138 • fax 763.295.4434  
sales@electromn.com • www.electromn.com

# TABLE OF CONTENTS

<u>Description</u>	<u>Page</u>
System Components	1
System or Water Flow	1
Room Thermostat Placement	1
Built in Temperature Control	2
Water Flow Calculation	2
Installation Requirements	2
Mechanical Installation	3
Electrical Hookup	4
Water Fill Procedure	6
Operational Tips	7
Troubleshooting Helps	8
<b>Drawings:</b>	
Piping, install kit	BX304
Hook-up	BH304
Internal Wiring (reference information)	BS304
Schematic, one line	BS309
Sensor Installation	BD705
Zones	BH007
Boiler Accessories	BL001

## GENERAL

As stated, this product series applies to underfloor hydronics heating. The basic **components** for an electric energy heating system typically includes:

1. Electric Mini-Boiler itself – covered by this manual
2. Thermostat control – covered by this manual
3. Plumbing kit or piping material at the boiler itself - Can be ordered as a kit, reference catalog number EMB-PK.
  - These items are shown on plumbing installation drawing BX304.
4. Circulating pump - Typically sized for head pressure and system flow requirement, typical catalog number EMB-P2.
5. The underfloor circulating tubes and manifolds - Provided and manufactured by others, not covered in this manual.

## APPROVED TUBING/PIPING

When plumbing this boiler and its peripheral parts to the loop system, all plumbing parts and/or tubing must be sealed to prevent entrance of oxygen.

**Use only tubing or polyethylene tubing with oxygen Diffusion Barrier (ie. PEX).**

## WARMFLO AQUASTAT

This model is factory equipped with the WarmFlo® comfort module setup specifically for boiler water temperatures. During installation the sensor must be installed within the pipe well (see Mechanical section) and the controller modulates or regulates the elements to maintain a preset maximum or preset operating temperature. The circuit board has a screwdriver adjustment (see Operational Tips section) for setting the operating temperature point.

During initial turn on (slab stat call for heat) both elements come on full. When the water temperature reaches the set point, the first 4.5 kW element begins turning off and on in an attempt to regulate at this specific temperature. Assuming proper flow, the element power will regulate to maintain this preset temperature. If Stage 1 is totally off and the temperature overshoots by 5°, Stage 2 element is also turned off.

## ROOM THERMOSTAT PLACEMENT

Comfort and proper space heating response is a direct relationship to the room thermostat type and the placement of the thermostat sensing bulb. Typically an underfloor heating system can be broken down into two categories.

- **Energy storage, water tubing is under the concrete or within the sand base** - The controlling thermostat must have a remote bulb, and this remote bulb must sense the concrete slab temperature (slab stat). Coordinated with the concrete pour, install a ¾" PVC, minimum bend radius of 7 inches, and locate at approximately center (vertical) of the concrete slab. The thermostat sensing bulb can later be pushed down this PVC conduit. If the slab is already poured without conduit for slab stat, use electronic remote sensing thermostat such as Electro Industries' ES-24-SRO. This type of device only requires a ¼" hole drilled in the concrete at some center wall location.
- **Quick response, hydronics tubing just under the concrete surface, no flooring material over the concrete** - In this case, heated water can directly radiate into the room, a standard wall mount room thermostat is adequate. Mount room thermostat on an inside wall similar to most heating systems.

Comment: If the slab was poured without the conduit, Electro Industries can provide a remote sensing slab stat with a remote sensor requiring only a ¼" hole. If it is at an inside wall, the ¼" hole need only be 1' or 2" away from the plate. If it is an outside wall you should go in about 24". Simply insert the sensor about 2" and fill with basic silicone to keep the sensor protected within the hole.

## TEMPERATURE CONTROL

The hi-limits within this unit are for safety purposes only. The system installation must have a proper responding slab sensing thermostat to properly turn the boiler on and off. If the water flow is greater than the minimum GPM specified, this boiler should not reach hi-limit and the hydronics loop should continue to flow in the normal heating pattern until the operating slab stat is satisfied. If hi-limiting is experienced prior to satisfying the operating slab stat, there is probably a water flow problem.

The WarmFlo® aquastat sensor is designed to control the temperature at the set point; however, depending upon the sensor location, water flow through the pipe at the sensor well, and the non-failure of the circuit board; the temperature of this unit should never reach hi-limit (160°). The limits are provided as a safety backup to the WarmFlo® modulator.

## INFORMATION/WATER FLOW CALCULATIONS

Water flow, GPM, can easily be calculated if the temperature rise across the electric boiler can be measured.

The formula below can only be used when the temperature rise is stable and the boiler is not hi-limiting. In other words, verify constant current draw and stable outlet temperatures for at least 15 minutes.

$$\text{GPM} = \frac{\text{Volts} \times \text{Amps} \times 3.4}{500 \times \text{Temp. rise}} \quad \text{Example: } \frac{240 \text{ volts} \times 36 \text{ amps} \times 3.4}{500 \times 10 \text{ degree rise}} = \frac{29376}{5000} = 5.8 \text{ gpm}$$

## INFORMATION/WATER FLOW CALCULATIONS – METRIC

$$\text{L/min} = \frac{\text{Volts} \times \text{Amps} \times 3.587}{251.04 \times \text{Temp. rise } ^\circ \text{C}} \quad \text{Example: } \frac{240 \text{ volts} \times 36 \text{ amps} \times 3.587}{251.04 \times 6^\circ \text{C rise}} = \frac{30991.68}{1506.24} = 20.57 \text{ L/min}$$

## INSTALLATION REQUIREMENTS

1. All installation work must be performed by trained, qualified contractors or technicians. Electro Industries, Inc., sponsors installation and service schools to assist the installer. **Visit our web site at [electromn.com](http://electromn.com) for upcoming service schools.**

### WARNING

ALL ELECTRICAL WIRING MUST BE IN ACCORDANCE WITH NATIONAL ELECTRIC CODE AND LOCAL ELECTRIC CODES, ORDINANCES, AND REGULATIONS.

### WARNING

OBSERVE ELECTRIC POLARITY AND WIRING COLORS. FAILURE TO OBSERVE COULD CAUSE ELECTRIC SHOCK AND/OR DAMAGE TO THE EQUIPMENT.

### CAUTION

This unit can only be used for its intended design as described in this manual. Any internal wiring changes, modifications to the circuit board, modifications or bypass of any controls, or installation practices not according to the details of this manual will void the product warranty, the CSA/us certification label, and manufacturer product liability. Electro Industries, Inc., cannot be held responsible for field modifications, incorrect installations, and conditions which may bypass or compromise the built-in safety features and controls.

2. This installation manual and Electro-Boiler products relate only to the addition of the Electro-Boiler to the hydronics system. The owner/installer assumes all responsibility and/or liability associated with any needed installation of the gas/oil boiler, pump, plumbing, system design, etc. Any instructions or comments made within this manual (or factory phone assistance) relating to the hydronics system or backup gas/oil boiler are provided as comments of assistance and “helps” only.

## CAUTION

Hazards or unsafe practices could result in property damage, product damage, severe personal injury and/or death.

- Remember, safety is the installer's responsibility and the installer must know this product well enough to instruct the end user on its safe use.

Safety is a matter of common sense - - a matter of thinking before acting. Professional installers have training and experienced practices for handling electrical, sheet metal, and material handling processes. Use them.

### CLEARANCES

	MINIMUM CLEARANCE FROM COMBUSTIBLE SURFACES		SUGGESTED MINIMUM SERVICE CLEARANCE	
BACK	0 INCH	0 MM	0 INCH	0 MM
LEFT	1 INCH	25 MM	6 INCHES	152 MM
RIGHT	1 INCH	25 MM	6 INCHES	152 MM
FRONT	1 INCH	25 MM	24 INCHES	610 MM
TOP	1 INCH	25 MM	24 INCHES	610 MM
BOTTOM	REQUIRED CLEARANCE – 10 INCHES/254 MM			

### AVAILABLE, ELECTRO INDUSTRIES, INSTALL PARTS OR KITS

EMB-BK	MINI-BOILER PLUMBING KIT BASIC
EMB-P2	PUMP KIT 1/25HP BOILER
ES-24-SRO	STAT DIG SLAB/ROOM/ROOM 24VAC
@WFS5	WATER SENSOR
5616	TRANSFORMER HTR 4X4 PLATE 40VA 24VAC
5576	AIR ELIMINATOR 3/4" ROLLAIRTROL
5456A	GAUGE PRES/TEMP 75 PSI/320DG F .25"
5453	VALVE RELIEF 30 PSIG .75" NPT MALE
5590	EXPANSION TAN K 40K BTU 20.1 GALLON
EMB-PK	MINI-BOILER INSTALL KIT PREFERRED
EB-5415A	ZONE CONTROLLER

### MECHANICAL INSTALLATION

## CAUTION

Electro Industries Inc. requires the use of dielectric isolation between the boiler vessel supply and return piping when the boiler is plumbed using copper or any other dissimilar metal. Damage to the vessel caused by galvanic corrosion voids Electro Industries' warranty.

Reference drawing BX304

At the outlet pipe the first fitting must be the supplied Tee with the sensor well fitting. It is important that the WarmFlo<sup>®</sup> aquastat sensor be as close as possible to the vessel, reference detail A on drawing BH304. Please reference BD705 for proper installation of the sensor. After the Tee and the sensor have been permanently installed, route the sensor cable along the right side of the unit and properly affix (do not puncture cable) to the wall.

The plumbing components and piping layout shown on drawing BX304 has been very carefully picked and should be plumbed as shown. When following this diagram, the water fill procedure becomes very simple and almost guarantees the removal of all air or prevents air locking problems. Experienced hydronic heating installers may be able to eliminate components such as regulated fill valve, check valve, temperature gauge, etc., but the inclusion of these components guarantees installation and initial operating success.

The key mechanical components required include:

- **Boiler/Plumbing Kit Placement** – This model series is wall hung and the vessel must be vertical.
  - The plumbing kit items are located adjacent to the boiler housing itself as shown on drawing BX304.
  - For future servicing, the unit itself must be installed a minimum of 18” above the floor. The elements are screwed in from the bottom.
  - Allow adequate space for cover removal and maintenance.
- **Expansion Tank** - As a closed loop hydronic heating system, a minimal expansion tank is required. This can be an air diaphragm tank as provided in the plumbing kit or a basic “empty” tank where air is compressed at the tank top.
- **Temperature/Pressure Gauge** - Recommended to observe the operation of the system. Actually a temperature gauge at the inlet and outlet is desirable.
- **Pressure Safety Valve** - This is required at the hot outlet and is furnished as a **loose** component with the boiler unit itself. Failure to install the provided, 30 PSI, pressure relief valve as shown void warranty and the CSA product listing.

Add the necessary pipe extension from the relief valve to the floor to prevent water damage on this unit or surrounding area.

- **Gate Valve/Drain Valve** - These are for servicing and easy fill purposes.
- **Circulating Pump** - Depending upon system lift and system loop resistance (feet of head), the proper circulating pump is required to guarantee the minimum GPM flow as specified on the cover sheet.

**Comment:** Circulator pump can be in the outlet or inlet. However, the circulator pump should “pump away from” the expansion tank.

- **Air Vent Relief** - Whenever there is a plumbing point higher than any of the components shown or an adjacent line (any vertical “U” trap), an air vent valve should be provided.
- **Building Water Supply Connection** – Reference drawing BX304, note 4, some local building codes require sophisticated check valve or anti-syphon check valve when the hydronics heating system is permanently connected to the domestic water system. The intent of this connection is temporary and for fill purposes only. The installer has the responsibility of complying with local building codes.

## ELECTRICAL HOOKUP

Reference drawing BH304.

### **WARNING**

DISCONNECT ALL ELECTRICAL POWER BEFORE ELECTRICALLY CONNECTING OR SERVICING THE UNIT. FAILURE TO DISCONNECT THE ELECTRICAL POWER BEFORE WORKING ON THIS PRODUCT CAN CREATE A HAZARD LEADING TO PERSONAL INJURY OR DEATH.

1. **Panel breaker sizes** – 4.5 kW Mini-Boiler will require 30-amp breaker, copper wire. 9 kW Mini-Boiler will require 50-amp breaker, copper wire.
2. **240 Volt Power Source** – route and install the proper current carrying conductors, suggested by local codes, from service panel fuse or circuit breaker. Nameplate shows current & KW rating.

**NOTE:** This model series is designed and equipped for 240-volt residential single phase. If this unit is used on 208 volt, energy capacity is reduced and there is a possibility of intermittent relay operation. Call factory for 208-volt application.

The source is either from the standard service panel or may be part of an off-peak separately metered panel/CT metered enclosure. Consult with local utility if questions on off-peak installations.

Since this unit is less than 10 kW, no fusing or circuit breaker at the boiler itself is required. The 240-volt (L1, L2, with copper ground) is connected directly to the left bottom terminal block.

## **WARNING**

USE ONLY COPPER WIRE FOR CONNECTION TO THE CIRCUIT BREAKER TERMINALS AND INSIDE THIS PRODUCT'S CABINET.

## **WARNING**

TO AVOID THE RISK OF ELECTRIC SHOCK OR DEATH, WIRING TO THE UNIT MUST BE PROPERLY GROUNDED. FAILURE TO PROPERLY GROUND THE UNIT CAN RESULT IN A HAZARD LEADING TO PERSONAL INJURY OR DEATH.

3. **Circulating Pump** – the two screw terminals (orange wires) represent a switch closure (see drawing – 10-amp maximum) to operate the circulating pump motor. **Voltage for the pump must come from a separate source.** Wiring entrance must be left KO, do not combine with thermostat cable or other control wiring.
4. **Operating Thermostat** – zone valve dry contact end switch is an operating contact, direct wired thermostats include:
  - **Standard Mechanical** – connect to control board “R” and “W”. **Important!** -Set thermostat internal heat anticipator to  $\emptyset.2$ .
  - **Electro-Stat** - (ES-24-SRO) 4 wire connection required. This is an electronic remote sensing device, remote sensor can be up to 50 feet, cut and splice as required. Use only stranded wire, shielded cable not required. The primary advantages include the capability for longer sensor and the sensor itself is less than 1/4”. This means it can be installed after the slab is complete by simply drilling a 1/4” hole, 1/8” slot, etc. slightly out from an inside wall.
    - \* R to R, W to W, C to C, green to ground
    - \* Use drawing EH304 (with ES product) for hookup, note change in load control connection.

## **WARNING**

VOLTAGE SEPARATION IS REQUIRED. THE 24Ø POWER AND PUMP WIRING MUST REMAIN LEFT OF THE BOTTOM PIPE. THE THERMOSTAT WIRES AND LOAD CONTROL WIRING (BLUE & BLUE/WHT) MUST EXIT AND REMAIN ON THE RIGHT SIDE OF THE BOTTOM PIPE.

5. **Load Management Interrupt Control** – this Mini-Boiler product has been pre-wired and designed for a power company load management receiver connection. This should not be altered in any manner!
  - A. Remove blue jumper wire
  - B. Extend or connect the two terminal screw points to the power company load control device.  
As shipped, this unit is only equipped for off-peak =N.C. logic. If reversed logic is required, contact the factory for modification.
  - Optional – if load management is not used, simply leave the blue wire jumper connected as shipped from manufacturer. Also for Electro-Stat the load control connection is at the Electro-Stat “R” terminal.
6. **Zone Valve** – do **not** power from EMB internal transformer. Contractor needs to install separate 24VAC transformer to operate zone valves. Suggest adding zone interlock control, EB-5415A . Call factory.
7. **Inspection/final check** – Verify all electrical connections are tight (including factory connections), verify there is proper spacing between all power and electrical wire/terminals, and verify top high limit manual reset is “in”. During shipping freight vibration there are times when the boiler vessel top manual reset high limit is “popped out”.

## **WATER ADDITIVES**

1. Unless the source water is unusually poor and/or rust elements, additives are not required. It is recommended the water source as shown on drawing BX304 comes through the household water softener.

2. Impurities within a closed loop hydronics boiler are considerably less damaging than the typical domestic water heater. In a closed loop electric boiler, the water impurities “boil out” and the system essentially reverts to pure water. As a closed system, this “pure water” becomes the operating mode. In the case of domestic water tank, there is always new water entering with new impurities.
3. However, if additives are required, use the recommendations and source from your local professional plumber, specializing in hydronics heating systems.

## **WATER FILL PROCEDURE**

The following procedure only applies to the prepackaged plumbing kit and/or when the system is plumbed exactly as shown on drawing BX304.

1. Connect the temporary household water supply source (probably hose connection) to the "supply water connection" input.  
**NOTE:** If supply water connection is permanent, some local building codes may require special anti-siphon check valve, PRZ check valve, or equivalent between the Mini Boiler fill regulator and the domestic water source or the city water connection.
2. Connect a drain hose to lower hose bib, "drain valve".
3. **Open** "drain valve" and **close** "inlet gate valve" (between drain valve and boiler bottom inlet).
4. Verify “top gate valve” is **open**.
5. Do not apply 24Ø volt heating power during water fill sequence.
6. **Open** "water supply valve" and **open** household water supply source.  
This may be at normal household pressure (4Ø to 6Ø PSI), the auto-fill valve regulator keeps the hydronics loop at its proper low pressure.
7. Allow system to circulate, discharging through drain valve, **for at least 1Ø minutes**.
8. Put your ear against the metal pipe and listen for air bubbles. If the water flow is consistent and quiet, the system is probably purged and water filled.
9. **Close** the "drain valve". **Open** the "inlet gate valve".
10. The cold system pressure at the gauge should be approximately 1Ø to 14 PSI.
11. **Close** "water supply valve" and disconnect water supply.
12. Optional – The circulating pump can be energized during this fill operation by having the 240 power main source breaker off and simply jumpering the 2 screw terminals for the pump wire connection.

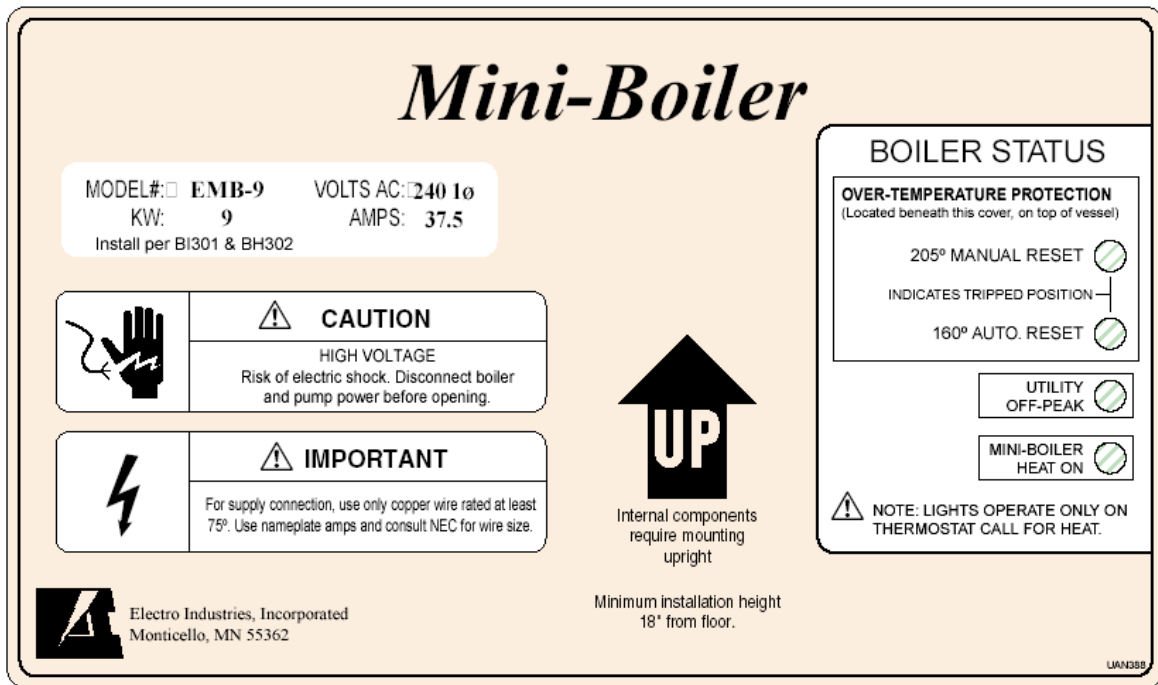
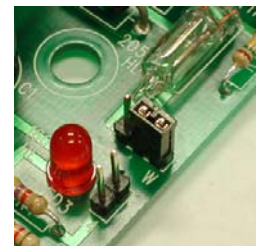

Figure 1

### OPERATIONAL TIPS

- Indicator lights – there is a set of four indicator lights on the lower right corner of the front cover with an identical set of four indicator lights on the internal circuit board itself. Figure 1 is a reproduction of the front decal giving definition and information for using these indicator lights. Note the statement that there must be a call for heat before attempting to interpret the indicator lights.
- 240 volt element power current flow can be measured when the external operating thermostat is calling for heat. There are no delays.
  - Assumes off-peak mode.
- The operating thermostat heat call can be verified by the red LED marked “Mini-Boiler heat on” located on front cover.
- The 160° (71° C) hi-limit is automatic reset.
- The 205° (96° C) hi-limit is manual reset and under the cover, located on the vessel top, left.
 

**Warning:** This 205° (96° C) manual reset controls the 240 power to the elements. Therefore, open the boiler disconnect prior to removing cover and prior to attempting to reset this limit. Note: Reset tab is brass in color and located on the side of the hi-limit.
- Via a small pin jumper arrangement on the control board, the circulator pump can be a direct function of the “W” input or interrupted by the load control device (even though there is a W input). This diagram illustrates this pin jumper arrangement. This unit is factory setup in the “W” position meaning the pump will always run as a direct function of “R” to “W” operating thermostat. By simply moving this black 2-position jumper to the “L” the pump will be turned off during load control interrupt.
- At outlet temperatures of approximately 120° F (53° C), the maximum system pressure should be approximately 18 PSI (124 kPa). If the PSI (or kPa) increase from cold water to operating hot water is more than approximately 3 to 4 PSI (20.6 to 27.5 kPa), the expansion tank is too small.
- Check for water leaks and repair as required.
- If flow seems to be a concern, determine both inlet and outlet water temperature and apply GPM (L/min) formula detailed in previous section “Information/Water Flow Calculations”.



## WARMFLO AQUASTAT OPERATION

Sensor cable installation – see previous paragraph, Mechanical.

Determine from floor tubing supplier design outline the desired floor temperature. Typically this relates to floor covering and tube placement design. Set the aquastat set point for desired warm water outlet.

The temperature set point is selected by a small screwdriver switch on the control board. Use the following chart:

Switch Position	Set Point
0	85
1	95
2	105
3	115
4	125
5	135
6	145
7	150

The green LED on the circuit board is on whenever Stage 1 electric element is on. This can either be full on, pulsing at a slow rate, or full off.

## TROUBLESHOOTING HELPS

Monitor – the green LED to the left of the dial switch not only indicates the first element operating on/off, but also provides some sensor quality information. If this LED is pulsing, there is either a shorted sensor, open wire to the sensor, or some sensor wiring error. The internal logic is not receiving temperature information from the sensor tip.

- The default for a bad sensor – boiler operates at half capacity, stage 1 on, stage 2 off.

### Sequence

- At heat call, elements 1 and 2 are full on.
- As the outlet temperature approaches the set point, element 1 begins to pulse modulate.
- At set point element 1 is off or 0%.
- At +5° above set point element 2 turns off.
- At set point element 1 again begins to modulate.
- At 5° below set point element 1 is at 100% and element 2 would again turn on.

**Mechanical hi-limit, top vessel screw-in, automatic reset** – this is at about 160° F, opens the red/white wire loop. This can be monitored by the “Auto Reset” front indicator light. As the water cools to approximately 120° it should self reset and restart.

**Manual reset limits** – surfaced mounted to the top of the vessel, opens at 205° F. This actually opens the current carrying leg to each element and prevents 240 power from reaching the element. This can be monitored from the “Manual Reset” front indicator light.

To reset this device, notice a small shiny lever protruding from one side of the black insulator. Simply push this lever inward and it should snap.

**Comment:** These lights will only be active during a heat call and when the element relay is closed.

## WARMFLO TEMPERATURE BYPASS TROUBLESHOOTING OR TESTING

Adding a jumper between “W” screw terminal and tab marked “E” bypasses the temperature sensing and WarmFlo control. In other words, with the jumper installed a “W” input represents 9 kW, full on.



ELECTRO INDUSTRIES, INC.

2150 West River Street, PO Box 538, Monticello, MN 55362  
763.295.4138 • 800.922.4138 • fax 763.295.4434  
sales@electromn.com • www.electromn.com

# "BASIC" MECHANICAL PIPING DIAGRAM - WARMFLO

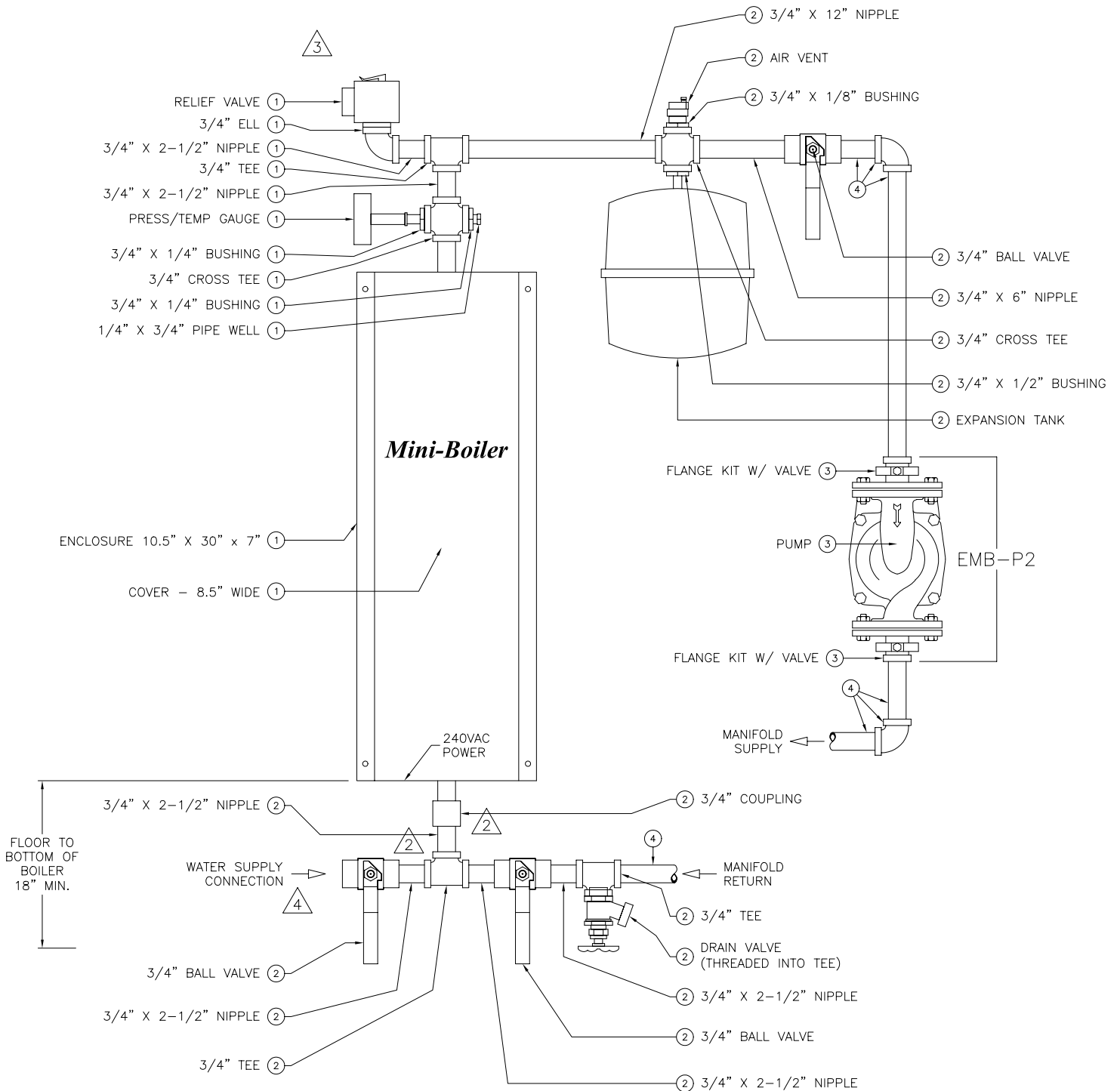

## LEGEND

- ① COMPONENTS INCLUDED WITH EMB-W-9, EMB-W-90
- ② COMPONENTS INCLUDED WITH EMB-BK KIT
- ③ COMPONENTS INCLUDED WITH EMB-P2 (PUMP) KIT
- ④ COMPONENTS NOT INCLUDED, SHOWN FOR REFERENCE ONLY

## NOTES:

1. INSTALLATION KIT (PART NUMBER EMB-BK) INCLUDES ALL PIPING PARTS (LESS PUMP & FLANGES) EXTERNAL TO THE 9.5" X 30" X 7" ENCLOSURE.
2. 3/4" COUPLING AND 2-1/2" X 3/4" NIPPLE VERY IMPORTANT. BOTTOM KNOCKOUT ACCESS REQUIRED FOR ELECTRICIAN.
3. ADD NECESSARY DRAIN PIPE.
4. SEE INSTRUCTION MANUAL FOR PRESSURE CONCERNS AND MAY NEED BACKFLOW PREVENTER.
5. SLAB STAT, ORDER NUMBER: ES-24-SRO.



# "PREFERRED" MECHANICAL PIPING DIAGRAM - WARMFLO

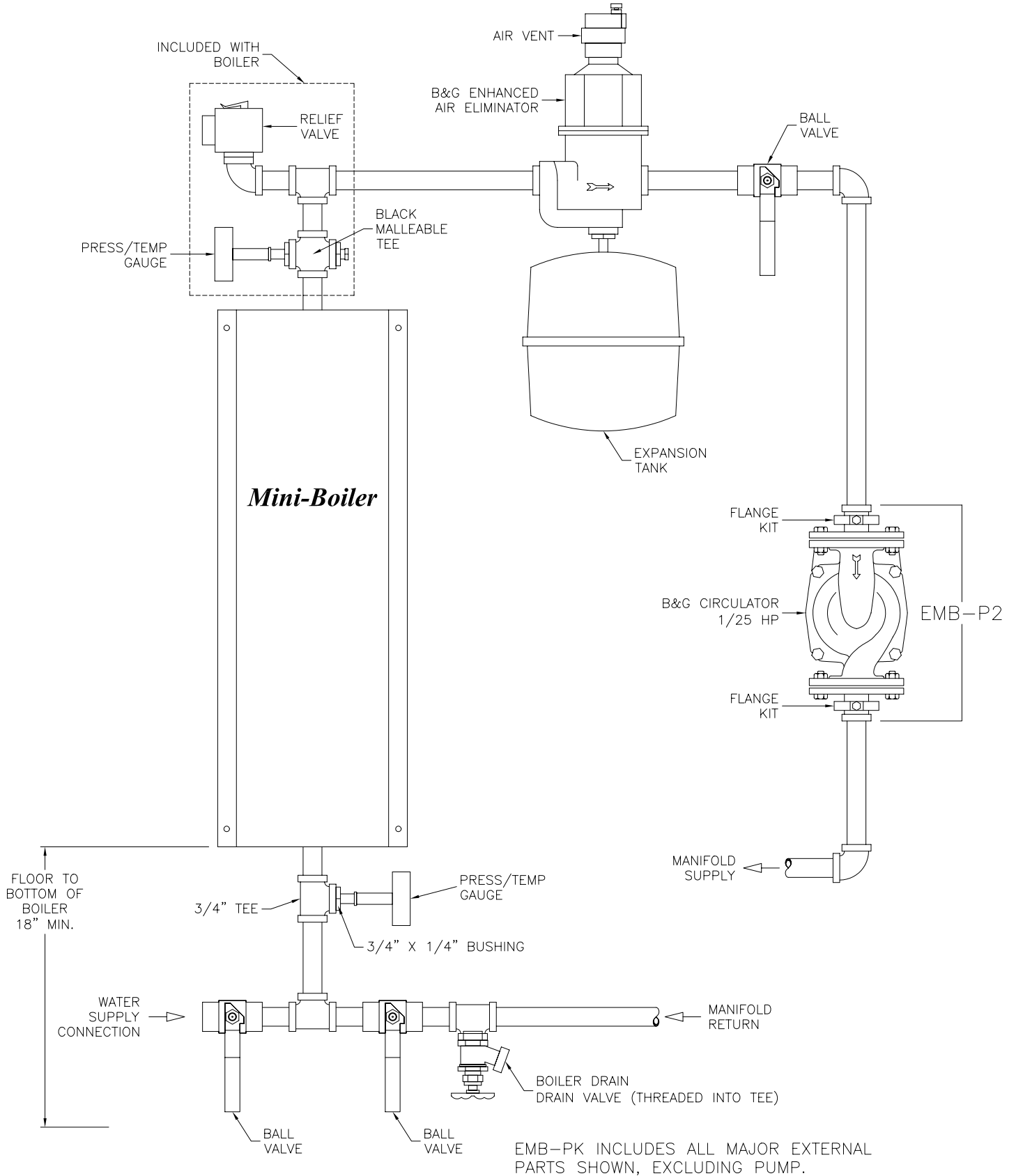



# MINI-BOILER HOOKUP (EMB-W-9) MULTI-ZONE, ANY NUMBER OR SIZE.

SEE  
PAGE 1

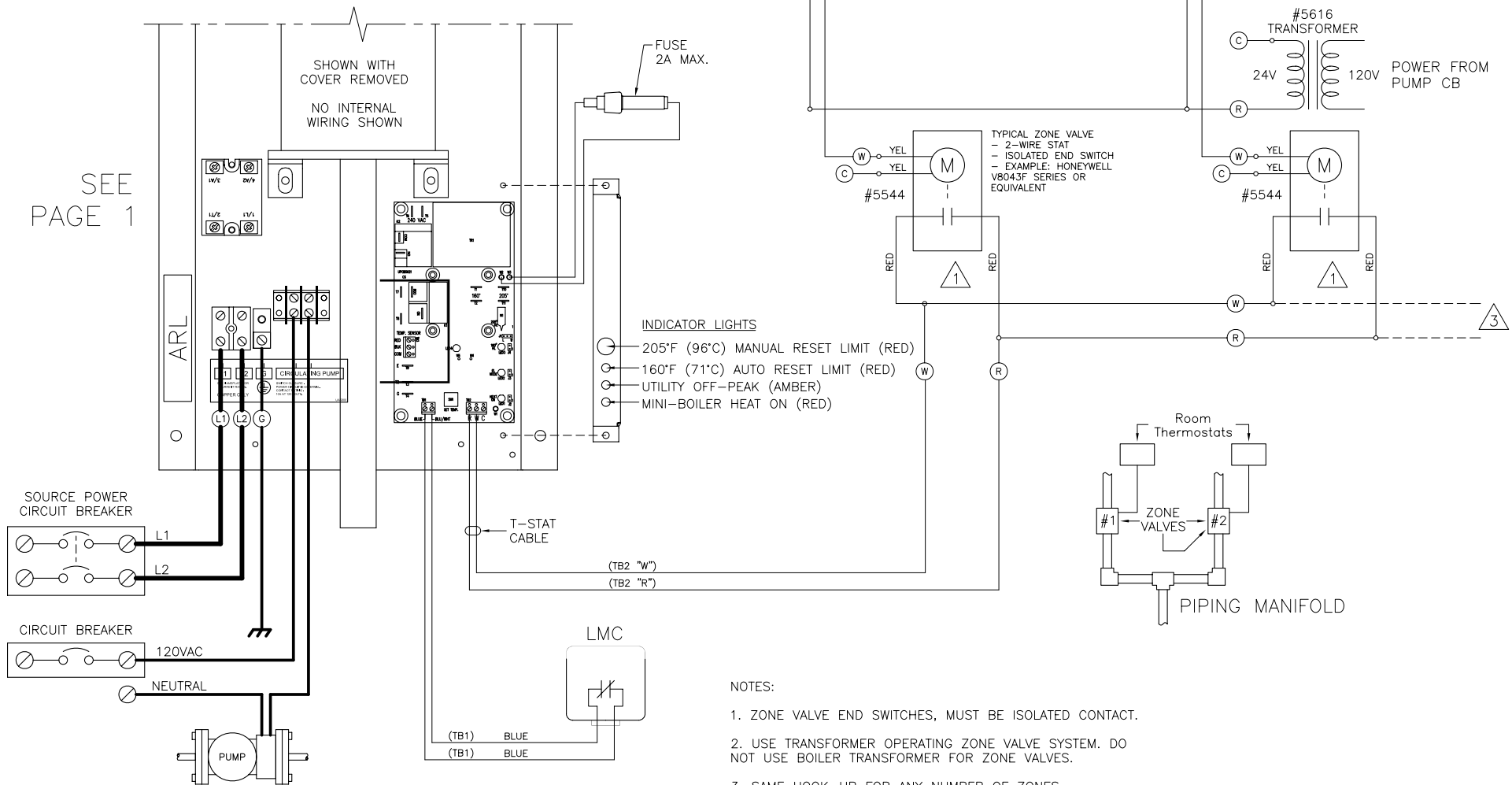

NOTES:

1. ZONE VALVE END SWITCHES, MUST BE ISOLATED CONTACT.
2. USE TRANSFORMER OPERATING ZONE VALVE SYSTEM. DO NOT USE BOILER TRANSFORMER FOR ZONE VALVES.
3. SAME HOOK-UP FOR ANY NUMBER OF ZONES.



# MINI-BOILER (EMB-W-9) WIRING SCHEMATIC

ID	DESCRIPTION
HL#	HI-LIMIT
E#	ELEMENT
COM	COMMON
NO	NORMALLY OPEN
T##	TAB NUMBER (CIRCUIT BOARD)

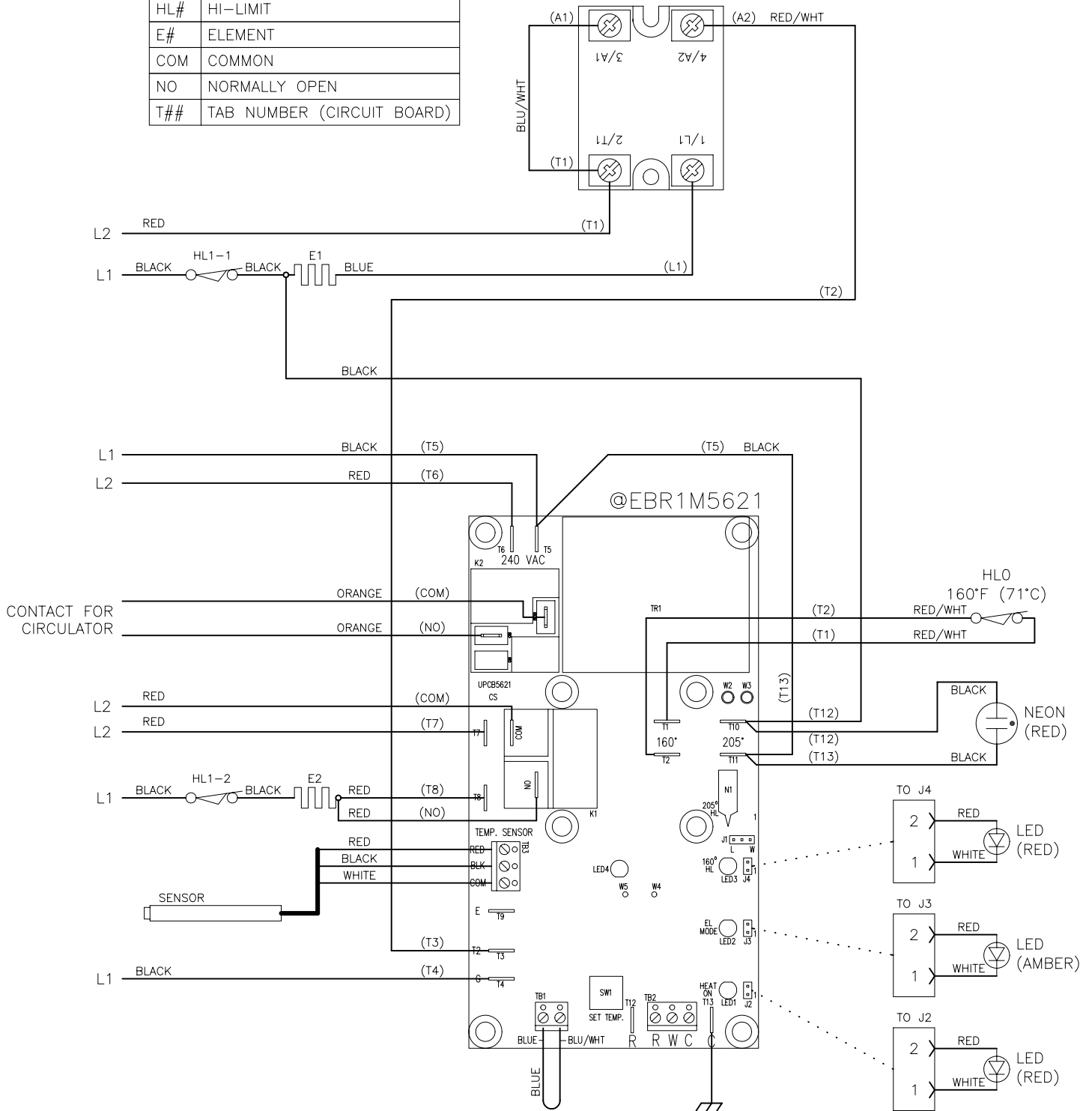

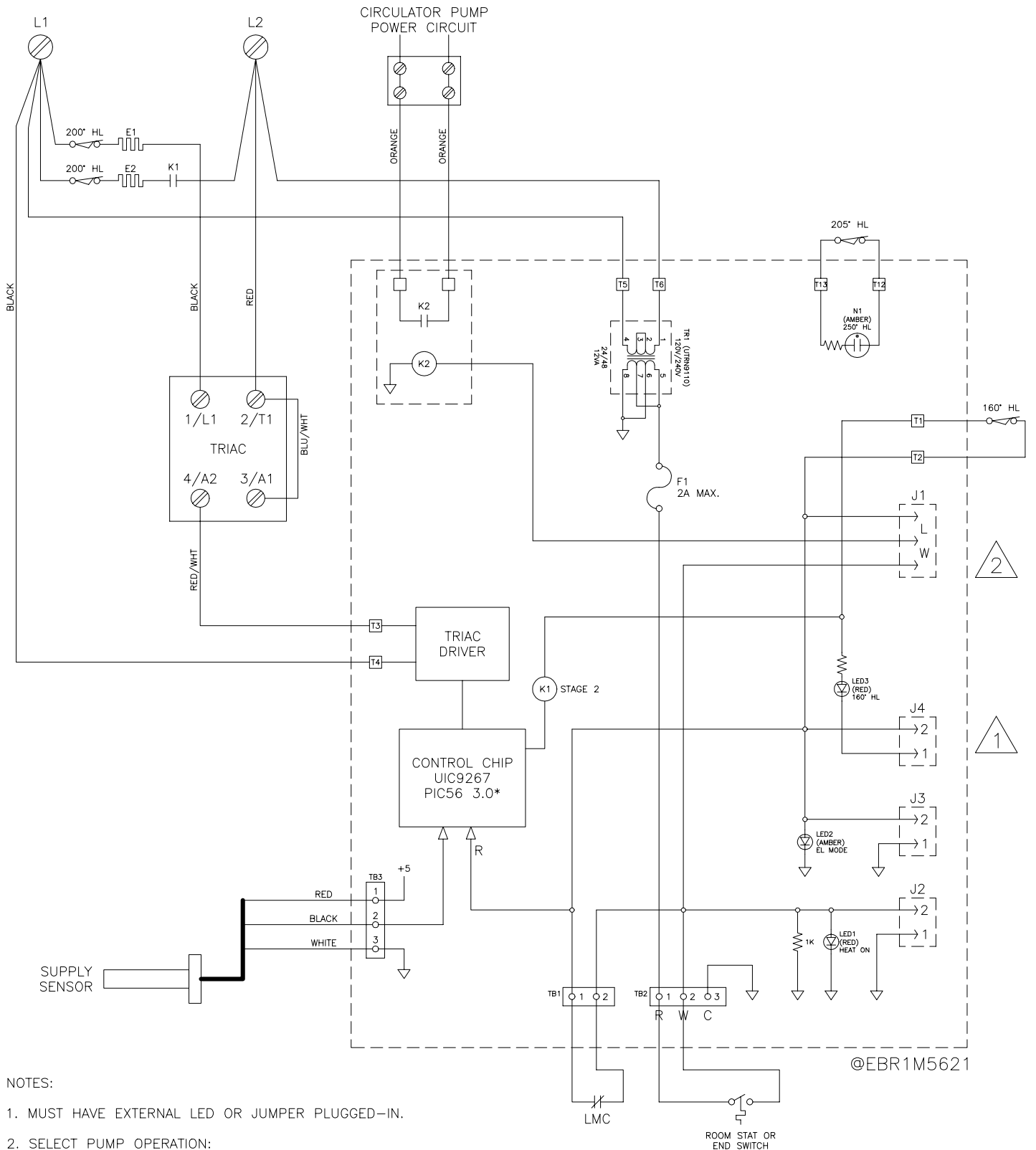

NOTES:

1. MUST HAVE EXTERNAL LED OR JUMPER PLUGGED-IN.
2. SELECT PUMP OPERATION:  
 L = OFF DURING LMC INTERRUPT  
 W = CONTROLLED BY STAT INPUT

 ELECTRO INDUSTRIES, INC. MONTICELLO, MN 55362		DESCRIPTION	
DRAWN		MINI-BOILER	
MEF		EMB-W-*	
REFERENCE DOCUMENT		SYSTEM SCHEMATIC	
BW302			
CHECKED	VIEW/DRAWING TYPE	SCALE	PART/ASSY/MODEL NUMBER
	SCHEMATIC	NTS	EMB-W-*
APPROVED	DRAWING STATUS	DOCUMENT DATE	SHEET
	RELEASED	04-23-02	1/1
		DOCUMENT NUMBER	BS309

## ELECTRO-BOILER™ SENSOR INSTALLATION



Once the pipe well has been installed. Liberally apply the supplied heat compound around the tip of the *Warmflo* sensor.



Then gently insert sensor into pipe well. **Note:** Using the tip of your finger, or another non-piercing object will aid in the insertion of the rubber grommet.



Once the grommet has been inserted into the well gently press the sensor until it reaches the bottom of the pipe well.  
Installation complete.



**ELECTRO INDUSTRIES, INC.**  
2150 West River Street, PO Box 538, Monticello, MN 55362  
763.295.4138 • 800.922.4138 • fax 763.295.4434  
sales@electromn.com • www.electromn.com

# WARMFLO BOILER ZONE VALVE HOOKUP

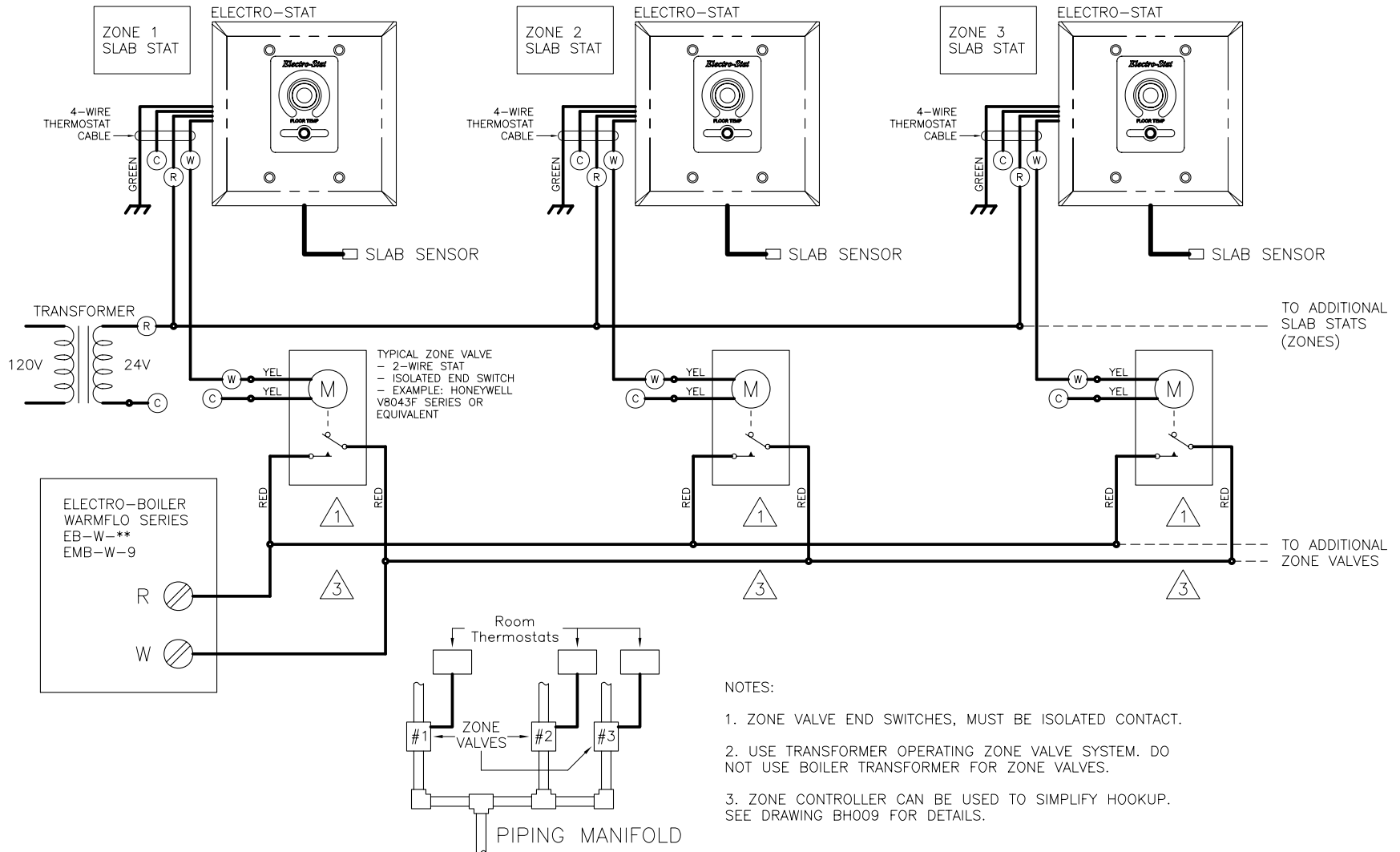

# WARMFLO BOILER ZONE VALVE HOOKUP

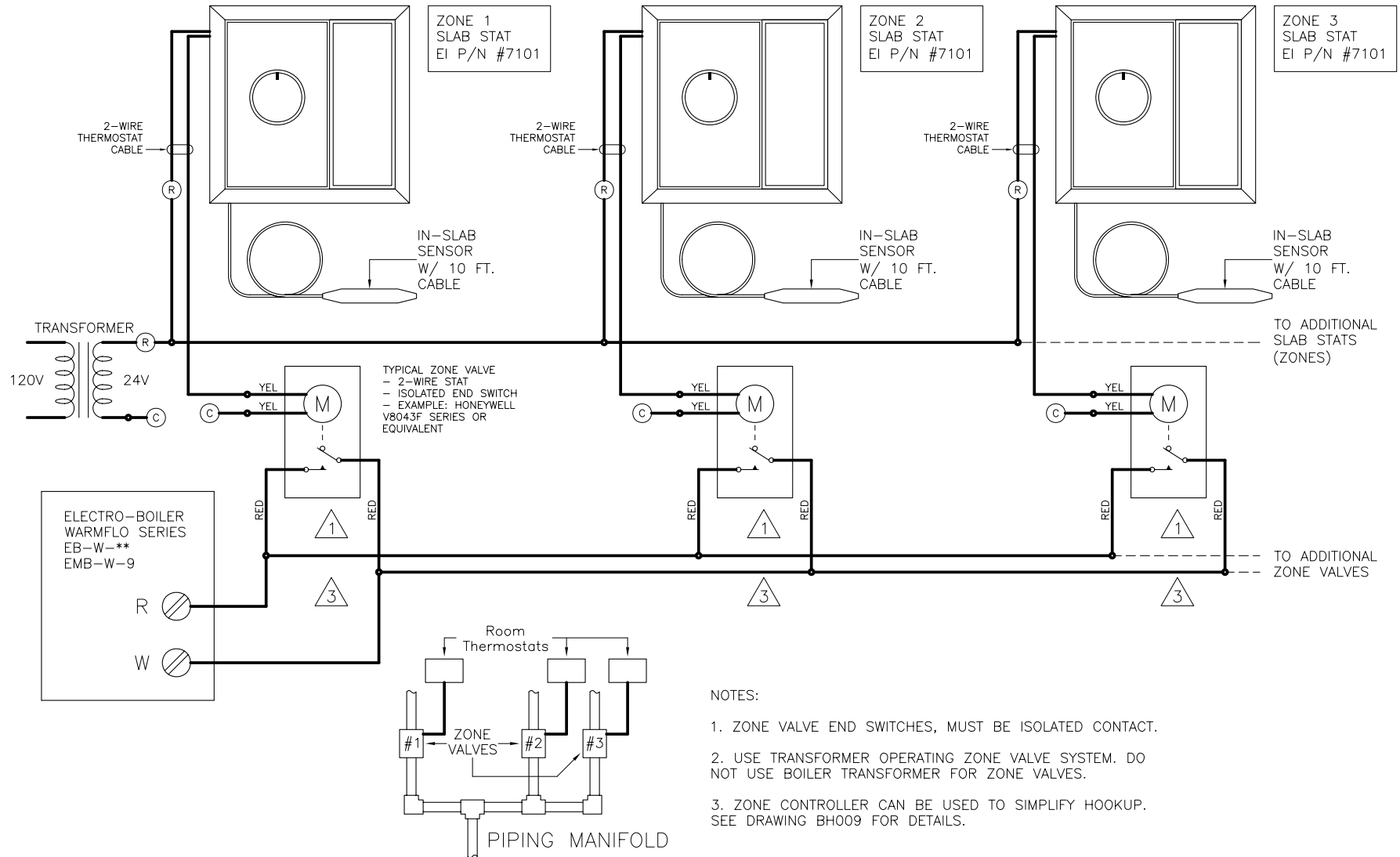

## NOTES:

1. ZONE VALVE END SWITCHES, MUST BE ISOLATED CONTACT.
2. USE TRANSFORMER OPERATING ZONE VALVE SYSTEM. DO NOT USE BOILER TRANSFORMER FOR ZONE VALVES.
3. ZONE CONTROLLER CAN BE USED TO SIMPLIFY HOOKUP. SEE DRAWING BH009 FOR DETAILS.



# BOILER ACCESSORIES

## ZONE CONTROLLER

This will simplify your wiring and make zoning applications much easier. In addition, enhanced communicating features have the ability to stage the electric boiler based upon the connected zone capacity.

### Standard Features

- **Utility load control**
- Terminal block wiring, visual wiring layout
- Indicator lights showing zone operation
- 24-volt, 40VA transformer 120/208/240 connection
- Fuse protection
- Priority option
- Dual temperature operation
- Applies to digital or standard thermostats
- Dial switch, select each zone capacity



### Pumps, Actuators, Valves

- EB-ZTA-1 - install within boiler cabinet
- EB-ZEA-1 - with enclosure and 40VA transformer
- EB-ZEA-2 - add additional 4, enclosure and 40VA

### Pumps

- EB-Z2P - two pumps with priority and dual temp.

### Zone Valves

- EB-ZTS-1 - install within boiler cabinet, encl. option
- EB-ZTS-2 - add additional 4, enclosure and 40VA

### All Others

- EB-ZXA-1 - universal, pumps or valves, non-communicating, for any boiler
- EB-ZS-4 - automatic staging system for Brand X boilers or dual EB-R, -L, -E Series
- EB-ZC-4 - wiring and convenience interface, isolated boiler end switch
- EB-5415A - low cost, 2 or 3 zones, sheds one boiler stage (Mini-Boiler enhancement)

## SLAB STAT

Sensing and controlling the system based upon radiant floor surface temperature or the concrete mass has very positive benefits. Radiant floor air stat in the same area as a forced air roomstat presents serious control problems. A remote sensing slab stat for the radiant floor removes this issue.

Remote sensing slab stat is required for storage applications.



ES-24-BR

## SWITCHING RELAY - EE-5051

This DPDT 24-volt switching relay provides a convenient solution to any AC or DC application.



- **Ideal for zone pumps**
- 24V coil
- 120V, 10A, contact sets
- Easy to wire and nicely packaged

## MULTI-BOILER - EB-C-STG5

Electrically connects between 2<sup>nd</sup> and 3<sup>rd</sup>, 3<sup>rd</sup> and 4<sup>th</sup>, etc.

### OTHER OPTIONS

- SOT-1 Switchover to standby, total run time
- 5701 Single feed bus for 2 CB's (SQ-D CB)
- 5702 Single feed bus for 3 CB's (SQ-D CB)
- EB-S-SB Dual boiler option for EB-S Series
- WF-ANZ\* WarmFlo Analyzer, now applicable to WO and WA Series

Specifications subject to change without notice, all rights reserved.



**ELECTRO INDUSTRIES, INC.**  
2150 West River Street, PO Box 538, Monticello, MN 55362  
763.295.4138 • 800.922.4138 • fax 763.295.4434  
sales@electromn.com • www.electromn.com

## TWO SUPPLY WATER TEMPERATURE REQUIREMENT

- Handled as the priority zone on multi-zone (EB-ZEA-1) or two pump (EB-Z2P) controllers
- Priority switch on, zone 1 active - TS boiler automatically changes to 150° (or selection 176°) supply water setting
- All other zones are held off
- With zone 1 satisfied or 60-minute timeout, the boiler automatically returns to the preset temperature and reacts to the other zones

Low Temp	High Temp
Radiant, slab	Radiant, staple up
Radiant, slab	Baseboard
Radiant, slab	Fan coil
Radiant, slab	Water heater, side arm
Radiant, slab	Hanging unit heater (garage, shop, etc.)

## INSTALLATION PLUMBING KITS

These installation kits provide the critical plumbing components needed for easy installation of the Electro-Boiler. **In addition** to the items shown in the matrix below, each kit includes all necessary ball valves, drain valve, tees, elbows, nipples, bushings, couplings, etc. for direct connection to circulator pump and/or manifold.

Electro Industries' boilers come standard equipped with outlet temperature/pressure gauge, pressure relief safety valve, and when applicable, the WarmFlo™ electronic control sensors. These kits provide the additional components for easy installation:

Model	Application	Return Gauge	Expansion Tank	Air Vent
EMB-BK	All EMB Series		2.1 gal. (7.9 L), 40,000 Btu/h	Basic float type
EMB-PK	All EMB Series	✓	2.1 gal. (7.9 L), 40,000 Btu/h	Enhanced air separator, EAS
EB-PK-M	EB-MS, -MA, -MO Series	✓	4.5 gal. (17 L), 135,000 Btu/h	Enhanced air separator, EAS
EB-BK-TS	EB-S, -WA, -WO Series		4.5 gal. (17 L), 135,000 Btu/h	Basic float type
EB-PK-TS	EB-S, -WA, -WO Series	✓	4.5 gal. (17 L), 135,000 Btu/h	Enhanced air separator, EAS

## CIRCULATING PUMPS



**5585 - Mini-Boiler & 10 kW TS Series**

- 120V, 1/25 HP, maintenance-free wet rotor circulator
- Pump curve example - 5 GPM (19 L) @ 11 ft. of head (32.9 kPa)



**5586 - TS Series, Standard**

- 120V, 1/6 HP, maintenance-free oil lubricated circulator
- Pump curve example - 10 GPM (37.8 L) @ 20 ft. of head (50.8 kPa)



**5578 - 3/4" Pipe  
5582 - 1" Pipe  
5579 - 1-1/4" Pipe**

- Two flanges, with isolation valve

# **Electro Industries, Inc. Limited Product Warranty**

**Effective October 1, 2007**

Electro Industries, Inc. warrants to the original owner, at the original installation site, for a period of two (2) years from date of installation, that the product and product parts manufactured by Electro Industries are free from manufacturing defects in materials and workmanship, when used under normal conditions and when such product has not been modified or changed in any manner after leaving the plant of Electro Industries. If any product or product parts manufactured by Electro Industries are found to have manufacturing defects in materials or workmanship, such will be repaired or replaced by Electro Industries. Electro Industries shall have the opportunity to directly, or through its authorized representative, examine and inspect the alleged defective product or product parts. Electro Industries may request that the materials be returned to Electro Industries at the owner's expense for factory inspection. The determination as to whether product or product parts shall be repaired, or in the alternative replaced, shall be made by Electro Industries or its authorized representative. Electro Industries will cover reasonable labor costs to repair defective product or product parts for ninety (90) days after installation.

## **TWENTY YEAR (20) LIMITED WARRANTY ON BOILER ELEMENTS AND VESSELS**

Electro Industries, Inc. warrants that the boiler elements and vessels of its products are free from defects in materials and workmanship through the twentieth year following date of installation. If any boiler elements or vessels are found to have a manufacturing defect in materials or workmanship, Electro Industries will replace them.

## **TWENTY YEAR (20) LIMITED WARRANTY ON SPIN FIN ELEMENTS**

Electro Industries, Inc. warrants that the spin fin elements of its products are free from defects in materials and workmanship through the twentieth year following date of installation. If any spin fin elements are found to have a manufacturing defect in materials or workmanship, Electro Industries will replace them.

## **FIVE YEAR (5) LIMITED WARRANTY ON OPEN WIRE ELEMENTS**

Electro Industries, Inc. warrants that the open wire elements of its products are free from defects in materials and workmanship through the fifth year following date of installation. If any open wire elements are found to have a manufacturing defect in materials or workmanship, Electro Industries will replace them.



**ELECTRO INDUSTRIES, INC.**

2150 West River Street, PO Box 538, Monticello, MN 55362

763.295.4138 • 800.922.4138 • fax 763.295.4434

sales@electromn.com • www.electromn.com

## **THESE WARRANTIES DO NOT COVER:**

1. Costs for labor for removal and reinstallation of an alleged defective product or product parts, transportation to Electro Industries, and any other materials necessary to perform the exchange, except as stated in this warranty. Replacement material will be invoiced to the distributor in the usual manner and will be subject to adjustment upon verification of defect.
2. Any product that has been damaged as a result of being improperly serviced or operated, including, but not limited to, the following: operated with insufficient water or airflow, allowed to freeze, subjected to flood conditions, subjected to improper voltages or power supplies, operated with airflow or water conditions and/or fuels or additives which cause unusual deposits or corrosion in or on the product, chemical or galvanic erosion, improper maintenance or subject to any other abuse or negligence.
3. Any product that has been damaged as a result of natural disasters, including, but not limited to, the following: lightning, fire, earthquake, hurricanes, tornadoes or floods.
4. Any product that has been damaged as a result of shipment or handling by the freight carrier. It is the receiver's responsibility to claim and process freight damage with the carrier.
5. Any product that has been defaced, abused, or suffered unusual wear and tear as determined by Electro Industries or its authorized representative.
6. Workmanship of any installer of the product. This warranty does not assume any liability of any nature for unsatisfactory performance caused by improper installation.
7. Transportation charges for any replacement part or component, service calls, normal maintenance; replacement of fuses, filters, refrigerant, etc.

## **CONDITIONS AND LIMITATIONS:**

1. If at the time of a request for service the original owner cannot provide an original sales receipt or a warranty card registration then the warranty period for the product will have deemed to begin thirty (30) days after the date of manufacture and **NOT** the date of installation.
2. The product must have been sold and installed by a licensed electrical contractor, a licensed plumbing contractor, or a licensed heating contractor.
3. The application and installation of the product must be in compliance with Electro Industries' specifications as stated in the installation and instruction manual, and all state and federal codes and statutes. If not, the warranty will be null and void.
4. The purchaser shall have maintained the product in accordance with the manual that accompanies the unit. Annually, a qualified and licensed contractor must inspect the product to assure it is in proper working condition.
5. All related heating components must be maintained in good operating condition.
6. All lines must be checked to confirm that all condensation drains properly from the unit.
7. Replacement of a product or product part under this limited warranty does not extend the warranty term or period.
8. Before warranty claims will be honored, Electro Industries shall have the opportunity to directly, or through its authorized representative, examine and inspect the alleged defective product or product parts. Remedies under this warranty are limited to repairing or replacing alleged defective product or product parts. The decision whether to repair or, in the alternative replace, products or product parts shall be made by Electro Industries or its authorized representative.

**THESE WARRANTIES DO NOT EXTEND TO ANYONE EXCEPT THE ORIGINAL PURCHASER AT RETAIL AND ONLY WHEN THE PRODUCT IS IN THE ORIGINAL INSTALLATION SITE. THE REMEDIES SET FORTH HEREIN ARE EXCLUSIVE.**

**ALL IMPLIED WARRANTIES, INCLUDING WARRANTIES OF MERCHANTABILITY AND FITNESS FOR A PARTICULAR PURPOSE, ARE HEREBY DISCLAIMED WITH RESPECT TO ALL PURCHASERS OR OWNERS. ELECTRO INDUSTRIES, INC. IS NOT BOUND BY PROMISES MADE BY OTHERS BEYOND THE TERMS OF THESE WARRANTIES. FAILURE TO RETURN THE WARRANTY CARD SHALL HAVE NO EFFECT ON THE DISCLAIMER OF THESE IMPLIED WARRANTIES.**

**ALL EXPRESS WARRANTIES SHALL BE LIMITED TO THE DURATION OF THIS EXPRESS LIMITED WARRANTIES SET FORTH HEREIN AND EXCLUDE ANY LIABILITY FOR CONSEQUENTIAL OR INCIDENTAL DAMAGES RESULTING FROM THE BREACH THEREOF. SOME STATES DO NOT ALLOW THE EXCLUSION OR LIMITATION OF INCIDENTAL OR CONSEQUENTIAL DAMAGES, SO THE ABOVE LIMITATIONS OR EXCLUSIONS MAY NOT APPLY. PRODUCTS OR PARTS OF OTHER MANUFACTURERS ATTACHED ARE SPECIFICALLY EXCLUDED FROM THE WARRANTY.**

**THIS WARRANTY GIVES YOU SPECIFIC LEGAL RIGHTS, AND YOU MAY HAVE OTHER RIGHTS WHICH VARY UNDER THE LAWS OF EACH STATE. IF ANY PROVISION OF THIS WARRANTY IS PROHIBITED OR INVALID UNDER APPLICABLE STATE LAW, THAT PROVISION SHALL BE INEFFECTIVE TO THE EXTENT OF THE PROHIBITION OR INVALIDITY WITHOUT INVALIDATING THE REMAINDER OF THE AFFECTED PROVISION OR THE OTHER PROVISIONS OF THIS WARRANTY.**