

**Ice and Snow Detector****605100A Series****Installation, commissioning and servicing instructions****Function**

The 605100A ice and snow detector is a microprocessor-based detector which activates a single zone melting system. The detector uses inputs from connected sensor(s) to provide automatic early detection of ice and snow conditions. Matching sensors include slab sensors for use in the detection of ice & snow on pavement type surfaces, or gutter sensors for the detection of ice & snow on elevated surfaces such as rooftops, satellite dishes and gutters.

When the detector senses a need for heat, the output (isolated SPST dry contact rate 24V – 6A) relay closes activating a heating system and when in the “no heat needed” mode, the output contact is opened. An optional “idle mode” function allows a slab to remain at an elevated temperature, to allow faster melt response in the event ice or snow conditions come about.

The large liquid crystal display (LCD) allows for viewing the system status and operating information. The detector allows for adjustments of moisture detection sensitivity, warm weather shut down (WWSD) temperature, minimum heating time, cold weather cut out (CWCO) temperature, and idle temperature (if option selected). A 24VDC alarm output activates if there is a failure in the detector or in a sensor.

U.S. Patent 6,276,202

**Technical characteristics**

Materials:	Polycarbonate
Ambient temperature: Indoor use only	32 to 120° F (0 to 50° C)
Humidity:	0 to 95% non-condensing
Power requirements:	24 VAC 20 VA
Power consumption (including sensor power):	20 VA
Dry contact output relay voltage	24 V
Dry contact output relay load rating	6 Amp resistive / 2 Amp reactive
Alarm output voltage max load	24VDC = 15mA
Minimum heating time adjustment:	30 to 600 minutes
Detecting temperature range – Active mode	-25 to 40°F (-32 to 5°C)
Hi temperature-warm weather shut down (WWSD) adjustment	26 to 40°F (-3 to 5°C)
Lo temperature-cold weather cut out (CWCO) adjustment:	-25 to 25°F (-32 to -4°C)
Idling mode temperature range – Active mode:	-50 to 40°F (-45 to 5°C)
Idling mode low temperature cut out adjustment:	-50 to 25°F (-45 to -4°C)
Moisture sensitivity adjustment:	5 to 95
Agency approval	CE Marked

## Table of Content

1. Features .....	3
2. Operating principle .....	3
3. Introduction .....	4
4. User interface .....	4
5. Operating state indicator .....	4
6. General pushbutton functions .....	4
7. General display functions .....	5
8. Menu structure .....	5
9. Quick Setup menu.....	6
10. Test menu .....	6
11. Show Status menu .....	7
12. Configuration menu .....	8
13. Administration menu.....	9
14. Operating states .....	9
15. Operational modes .....	10
16. Error codes .....	11
17. Serial interface .....	13
18. Supported sensor types .....	13
19. Detector enclosure mounting .....	14
20. Detector wiring installation .....	14

## 1. Features

The 605100A is a fully featured ice and snow detector which can be configured to meet the most demanding of applications.

- **Universal applications:** Surface types such as walkways, parking lots, and driveways are monitored using our matching slab sensors. Surface types such as rooftops, satellite dishes and gutters are monitored using our matching gutter sensors. The default setting is for a single slab sensor.
- **Broad temperature detection range:** Detector can be adjusted to activate melting with surface temperatures as low as -25 °F and as high as 40°F. The default active temperature range is 5 °F to 35°F.
- **Two sensor operation option:** Detector can be configured with either one or two sensors (either slab or gutter type). When using a second sensor, heat activation occurs if either sensor detects ice or snow, thus providing greater detection flexibility and dramatically reducing the chances of potentially costly “missed melt” situations due to sun/shade movement. A second sensor also provides redundant reliability - in the event of a fault in one of the sensors, the detection system will continue to function with the other sensor. The moisture sensitivity can be adjusted independently for each sensor. The default setting is for one slab sensor.
- **Alarm activation:** Upon detection of a sensor or detector fault, a 24 VDC output signal is activated. Alarm code number also displays on LCD screen for easy troubleshooting. The signal can be connected to any compatible forwarding device. Especially useful for un-staffed, remote or “safety critical” applications.
- **Slab idling mode option:** Selectable option allows slab temperature to be maintained at an elevated level to allow for quicker melting when ice & snow conditions occur. Especially useful in extremely cold northern climates and in “safety critical” applications such as hospital emergency entry ways and corporate entry ways with heavy foot traffic. The default setting is for slab idle mode not activated.
- **Slab idling low temperature cut out:** Defines the temperature below which the detector will be switched off. Range is -50 to 25°F (-45 to -4°C). The default setting is 5° F.
- **Digital status indication:** LCD display and programming allows for easy setup and checking of detector status as well as temperature and moisture readings through a hierarchically structured menu tree.
- **Quick start menu:** Most applications can be started using the quick start menu saving time on the job.
- **Manual start/test heating time mode:** Allows the heating relay to be energized for the minimum heating run time selected and then returns to normal operational mode.
- **Detector programming flexibility:** Adjustable settings enable fine tuning and provide for use across a broad spectrum of applications and external conditions:
- **Minimum heating run time:** Adjustable minimum time for which the heating system will be kept operative once an ice or snow condition is detected. Range is 30 to 600 minutes. The default setting is 120 minutes.
- **Moisture sensitivity:** Adjustable level of sensitivity for moisture detection. Range is from 5 to 95. At value 5, the sensor is very sensitive and even slight moisture will be detected. At value 95, moisture will be very heavy before being detected. The default setting is 50.
- **Cold weather cut out (CWCO):** Defines the temperature below which the detector will be switched off. Range is -25 to 25°F (-32 to -4°C). The default setting is 5° F.
- **Warm weather shut down (WWSD):** Defines the temperature above which the detector will be switched off. Range is 26 to 40°F (-3 to 5°C). The default setting is 35°F.
- **Selectable temperature units:** Select Fahrenheit or Celsius temperature units. The default is Fahrenheit.
- **Serial Interface:** (with optional cable) for reading parameters and measured variables using a menu-driven *Ice Monitor* PC program.

## 2. Operating principle

Older system designs use exposed metal electrodes in their sensors to detect moisture. The exposed metal electrodes can accumulate dirt, suffer from corrosion, or get shorted by external conductive objects, causing maintenance or system failure. The function of the 605100A detection system is based on the behavior of the power consumption of a PTC resistor embedded in the sensors. The power consumption depends on not only the surface temperature, but also by the heat loss effect from evaporation when water is present.

Sensing cycle: Every 25 minutes, the detection system monitors for temperature. If the temperature sensor detects a surface temperature within the active mode temperature range, the detection system then checks for the presence of moisture by applying a small control power to the PTC sensing element to melt any possible ice or snow. After a time delay of approximately 90 seconds, the detection system determines whether the sensor surface is wet or dry by analyzing the power consumption of the PTC sensing element. If moisture is detected, the heating system activates for at least the minimum heating time. If no moisture is detected, the control power of the sensing PTC resistor switches off for 25 minutes before starting the sensing cycle over again.

### 3. Introduction

The 605100A is factory configured for use with one 605 series slab sensor. Operating temperature range, moisture sensitivity limits and minimum heating time are factory set, but can be easily adjusted using the Quick Setup menu. Advanced configurations such as two slab sensors, one slab sensor and idling mode, one gutter sensors or two gutter sensors can be accessed through the Configuration menu.

### 4. User interface

The 605100A has a two line LCD screen in order to setup and monitor the operation of the detector. The control panel has three push buttons; **Set**, **+** and **-**. The **Set** button is used for selecting and saving functions. The **+** or **-** buttons are used for scrolling within a menu. By pressing the **+** and **-** buttons together, you can Escape back to the previous menu. An LED multicolored light indicates detector status.

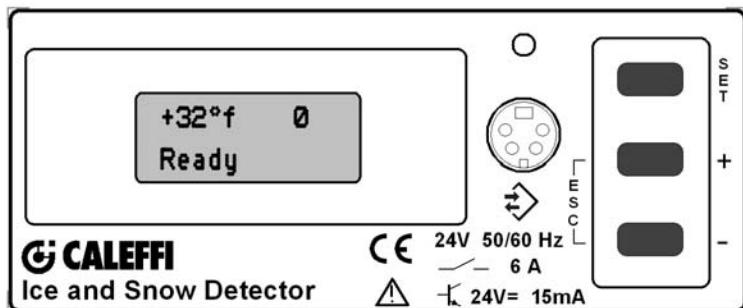

### 5. Operating state indicator

The operating state multicolored indicator LED light shows the following operating states:

Operating state	Description
<b>Green flashing</b>	System initialization
<b>Green</b>	System in service
<b>Green/Red flashing</b>	System in service, one or both sensors are faulty *
<b>Red flashing</b>	System not ready, detector is faulty **
<b>Red</b>	System out of service

\* In this failure state, the Show Status menu > Status Sensor x will display the error code of the sensor and the Alarm output will be activated.

\*\* In this failure state, the Show Status menu will display the error code of the detector and the Alarm output will be activated.

### 6. General pushbutton functions

Depending on the current menu selection, the three pushbuttons may have different functions. These functions are:

Pushbutton	Description
<b>Set</b>	General function <b>Select</b> or <b>Confirm</b> ; particular functions: <ul style="list-style-type: none"> <li>• go from Home Display to Main Menu</li> <li>• select the currently displayed submenu</li> <li>• return to the parent menu when “Back” is displayed</li> <li>• select the currently displayed module number</li> <li>• select the currently displayed parameter for modification</li> <li>• save the currently displayed parameter</li> </ul>
<b>+</b> or <b>-</b>	General function <b>Modify</b> ; particular functions: <ul style="list-style-type: none"> <li>• show previous/next menu item</li> <li>• modify displayed module number selection</li> <li>• modify current parameter value</li> </ul>
<b>+</b> and <b>-</b> *	General function <b>Abort</b> ; particular functions: <ul style="list-style-type: none"> <li>• return to the parent menu from a any menu item</li> <li>• abort current parameter modification without saving the changed value</li> </ul>

\* Press **+** and hold, then press **-** , or press **-** and hold, then press **+** will **Abort** the particular function.

## 7. General display functions

The unit communicates with the user through a LCD display with two rows of eight characters each. The following characters and symbols are used, independent of the current menu selection:

Display function	Description
-	Parameter value is currently being read
- x -	Value is (currently) undefined
- Λ -	Sensor loop impedance too high, e.g. open loop
- V -	Sensor loop impedance too low, e.g. short circuit
...	Secure function; selection of Yes is required,
OK	Secure function successfully completed
Err	Secure function unsuccessfully terminated
□	Mode = Off, Out of Service
▣	Mode = On, In Service
▣ !	Mode = On. In Service, Idling Mode enabled

Menu operation will be terminated three minutes after the last pushbutton; the unit returns to the Home Display.

## 8. Menu structure

### 1. Main menus

Menus	Description
<b>Quick Setup</b>	Allows configuration setup to meet most applications
<b>Test</b>	Allows to test each function
<b>Show Status</b>	View recent and current information
<b>Configuration</b>	Allows advanced configuration setup such a two sensor operation or idle mode
<b>Administration</b>	Allows restoring defaults, change of language and units of measure
<b>Back</b>	Return to Home display

### 2. Move between menus, settings, and parameters

When you have the top level menu displayed, as described above, you can move between the menus, settings, and parameters as follows:

- To navigate between the top level menu and between the sub menus underneath each top level menu, press the **+** Button or **-** Button.
- To choose a top level menu or sub menu, as well as the setting you want to configure and setting parameters you want to save, press the **Set** Button.
- To scroll up or down settings for a sub menu press the **+** Button or **-** Button.
- To define the parameters of a sub menu setting, press the **Set** Button to select parameter. Press the **+** or **-** Buttons to decrease or increase the parameter. Press the **Set** Button to save this parameter.
- To escape and return to the parent menu at any time, press the **+** and **-** Button together. For example, if you are on a setting screen for a submenu, pressing the **+** and **-** Button together will display the submenu for that setting.
- To exit the software menus and return to the top level menu, press the **+** and **-** Button together.

### 3. Initialization

When power is connected the following screen appears for five seconds

6051 En *f V01.03	Displays Detector Model , Language, Temperature Units and Software Version
----------------------	--

Followed by the **Home** display

+32*f 0 Ready	Displays Effective Slab Temperature, Heating Time Remaining (0 if off) and Detector Status
------------------	--

### 9. Quick Setup menu

The Quick Setup menus allow you to setup parameter for most applications. The Quick Setup menu is shown below.

Submenu	Setting	Function
Temp Hi Lim.	26 to 40° F	Adjust and set high temperature limit (warm weather cut out) The moisture detection cycle will not begin when the slab temperature is higher than the set value. Default 35° F
Temp Lo Lim.	-25 to 25° F	Adjust and set low temperature limit (cold weather cut out) The moisture detection cycle will not begin when the slab temperature is lower than the set value. Default 5° F
Moisture Limit	5 to 95	Adjust and set moisture limit system value in increments of 5. The value 95 represents a flooded sensor and 5 represent a dry sensor. Heating will not activate on when moisture is below the set value. Default 50.
Heat Time Min.	30 – 600 minutes	Adjust and set the minimum heating time in 10 min. increments. This is the minimum time the heating output relay stays energized. Default 600 minutes
Back		Returns to Quick Setup submenu by pressing Set

### 10. Test menu

The Test menus allow you to test the detector heating output relay and test the moisture detection of each connected sensors. The Test menu is shown below.

Submenu	Function
Heat Time Test <input type="checkbox"/>	Manually activates the heating output relay for minimum heating time. Select <input checked="" type="checkbox"/> to activate the heating relay and select <input type="checkbox"/> to deactivate the heating relay.
Sensor Test 1	Select sensor 1 or 2 to enter submenu for testing selected sensor
State S. On T+M	Displays operating state of selected sensor as On, or Off. The modes are T = temperature, M = moisture or T+M = temperature & moisture.
Sensor T +32*f	Displays sensor temperature of selected sensor
RemTime Mdet 0m	Displays remaining time before the next moisture detection cycle begins. Detection begins at the end of the minimum heating time. Values are 0 to 600
Start Mdet ...	Manually starts moisture detection cycle by selecting <b>Yes</b> . Select ... for no test
Last Moist. -x	Displays last moisture detection of selected sensor. Values are 5 to 95
Back	Returns to Sensor Test submenu by pressing Set
Back	Returns to Test submenu by pressing Set

## 11. Show Status menu

The Show Status menus allow you to view recent and current temperature, moisture and status values. The Show Status menu is shown below.

Submenu	Function
State Ready	Displays detector operating state; Reset, Inactive, Off, Ready, Active, Heating or Error
Error Code 0	Displays detector error code. 0 = no error, see detector error chart for complete listing
Slab Heat. [ ]	Displays slab heat state; [ ] = On or [ ] = Off
RemHeat Tim 0m	Displays remaining heating time (0 if Heating Demand or Slab Heating Off)
Slab T +32°F	Displays effective Slab temperature
Outdoor T --x-°f	Displays recent Outdoor air temperature (only if Idle Mode is enabled)
Status Sensor 1	Select sensor 1 or 2 to enter submenu for Show Status of selected sensor
State S. On T+M	Displays operating state of selected sensor as On or Off. Modes are T = temperature, M = moisture or T+M = temperature & moisture.
Error Code 0	Displays sensor error code. 0 = no error, see sensor error chart for complete listing
Sensor T +32°F	Displays moisture sensor temperature of selected sensor
Ambient T +32°F	Displays outdoor ambient temperature for selected sensor (maintain the last valid ambient temperature during inhibit period)
Last Moist. --x	Displays last moisture detection. Values between 5 to 95 (--x indicates no data was recorded)
InhibTim Tmp 0m	Displays remaining Inhibit time before temperature update. Values between 0 – 15 minutes
InhibTim Mdet 0m	Displays remaining Inhibit time before next moisture detection cycle begins. Value between 0 – 600 minutes
Back	Returns to Status Sensor submenu by pressing Set
Back	Returns to Show Status submenu by pressing Set

## 12. Configuration menu

The Configuration menu allows advanced configuration setup such as two sensor operation or idling mode. The Configuration menu is shown below.

Submenu	Function
Configu- ration	Configures detector and sensors
Operat. Mode <input type="checkbox"/>	<input type="checkbox"/> = Off (out of service), <input checked="" type="checkbox"/> = On (in service), or <input checked="" type="checkbox"/> != On (in service) + Idle mode
Temp Hi Lim. +34°f	Adjust and set high temperature limit (WWCO). Setting +26° f to +40° f
Temp Lo Lim. -15°f	Adjust and set low temperature limit (CWCO). Setting -25° f to +25° f
Temp Lo Idle -45°f	Adjust and set low temperature limit for idle model. Setting -50° f to +25° f
SlabIdle Temp +25°f	Adjust and set slab idle temperature. Setting -25° f to +40° f
Moisture Limit 50	Adjust and set moisture limit in increments of 5. Setting 5 to 95
HeatTime Min. 30m	Adjust and set the minimum heating time in 10 min. increments. Setting 30 – 600 minutes
Config. Sensor 1	Configures selected sensor. Select sensor 1 or 2 to enter submenu.
Sensor Typ Slab	Select sensor type: Slab = Slab, Gutt = Gutter, or OAT = Outdoor Air Temperature
Method Meas. T+M	Select measure method: T= Temp. only, M= Moisture only, or T+M= Temp & Moist
Moisture Limit -x	Adjust and set moisture limit increments of 5. Setting 5 to 95. Set to -x if only one sensor is used. A setting value will override the system value in the Quick Setup menu.
Back	Returns to Config Sensor submenu by pressing Set
Back	Returns to Configuration submenu by pressing Set

### 13. Administration menu

The Administration menus allow you to configure language, temperature units and restore factory defaults. The Administration menu is shown below.

Submenu	Function
Adminis- tration	Administration Menu
Language En	Select and set language: En = English or Fr = French. Default: En
Temp Units °f	Select and set temperature units: °f = Fahrenheit or °c = Celsius. Default: ° f
Factory Def. ...	Restores parameters to Factory Default: ... = No or Yes = Confirm
SW Vers. 01.03	Displays Software Versions
Back	Returns to Administration submenu by pressing Set

### 14. Operating states

The subsequent sections provide a description of the internal operating states of the detector unit and the sensors including the events that trigger the state and the functions performed in that state.

The operating state of the detector is shown in Home Display and Show Status menu, the operating state of the selected sensor is shown in Show Status> Sensor Status menu and Test > Sensor Status menu.

#### 1. Detector operating states

Operating states	Description
<b>Reset</b>	State immediately after initialization, does not occur in normal operation. If this state is displayed for an extended period of time this indicates a configuration problem.
<b>Inactive</b>	State immediately after initialization, does not occur in normal operation. If this state is displayed for an extended period of time this indicates a configuration problem.
<b>Off</b>	Detector manually disabled. Slab heating Off. All measured temperatures undefined Moisture detection cycles not activate.
<b>Ready</b>	Ready for operation: temperature not within activated window.
<b>Active</b>	Unit in operation: temperature within window, no moisture present
<b>Heating #</b>	Heating operation during initial minimum heating time: heating on and minimum heating time not yet expired. No interruption by temperature or moisture change.
<b>Heating</b>	Normal Heating operation after initial heating time expired: temperature within window, moisture present, heating on. Interruption possible if temp is not within activated window.
<b>Heating *</b>	Same as Normal Heating with Idle Mode: temperature within window, moisture present, heating on. Switches to Idle Mode if temp is not within activated window.
<b>Error</b>	Error condition: each active sensor faulty or internal error

## 2. Sensor operating states

Operating states	Description
<b>Reset</b>	State immediately after initialization, does not occur in normal operation. If this state is displayed for an extended period of time this indicates a configuration problem.
<b>Inactive</b>	State immediately after initialization, does not occur in normal operation. If this state is displayed for an extended period of time this indicates a configuration problem.
<b>Off</b>	Sensor manually disabled. Sensor temperature undefined. Moisture detection cycles not activated
<b>On T</b>	Sensor in service, temperature measurement. Continuous ambient temperature monitoring. Moisture detection cycles cannot be activated by the detector.
<b>Error T</b>	Sensor in service, temperature measurement faulty. Temperature sensor loop faulty. Sensor temperature and ambient temperature undefined.
<b>On M</b>	Sensor in service, moisture detection. Ambient temperature undefined. Moisture detection cycles can be activated by the detector
<b>Error M</b>	Sensor in service, moisture detection sensor loop faulty. Moisture detection cycles cannot be activated by the detector. Periodical evaluation of the moisture sensor loop
<b>Error MT</b>	Sensor in service, moisture detection faulty due to failed temperature measurement. Moisture detection cycles cannot be activated by the detector.
<b>On T+M</b>	Sensor in service, temperature measurement and moisture detection. Continuous temperature monitoring except during inhibit period. Moisture detection can be activated.
<b>Error T-M</b>	Sensor in service, temperature measurement active, moisture detection faulty. Continuous temperature monitoring. Periodical evaluation of the moisture sensor loop.
<b>Error T+M</b>	Sensor in service, temperature measurement faulty, moisture detection cycle cannot be activated by the detector as the temperature value is required.
<b>MoistDet.</b>	Moisture detection cycle in progress. Moisture detection cycles activated.

## 15. Operational modes

### 1. Moisture detection method

Due to the physics of the moisture sensors employed and their particular measurement method the moisture detection is not performed continuously but rather in intervals of approx. 10 to 25 minutes, depending on the sensor type. If two sensors are connected the detection cycles will alternate. Any moisture condition (or a change of such) can only be detected while the detection cycle is in progress (display shows sensor state "MoistDet").

Additionally, note that sensors which are activated to detect moisture only, still need their temperature sensor connected and ready for operation as the sensor temperature is required to determine the moisture. For this reason, these sensors will also generate an error message if "only" their temperature measurement is faulty.

To avoid erroneous moisture detections the supply voltage of the detector unit is monitored prior to and during a moisture detection cycle, and an error message will be generated if the voltage value is outside the valid operating range (see Sensor error codes").

The system automatically optimizes the duration of a moisture detection cycle, depending on sensor type, supply voltage and sensor temperature.

### 2. Ambient temperature of moisture sensors

Depending on the sensor type, the ambient temperature cannot be measured while a moisture detection cycle is in progress and for a inhibit period of time afterwards as the detection process causes a temperature change which is recognized by the built-in temperature sensor. During this inhibit period of temperature measurement inability the system will maintain the last valid ambient temperature.

### 3. Slab temperature

If two sensors are used to measure the slab temperature the effective slab temperature will be calculated according to the following rules (incorporating a hysteresis of  $\pm 1^{\circ}$  F each):

1. Both sensor values outside of the range defined by the temperature high and low limits: The effective slab temperature equals the average of both temperature values.
2. Both sensor values within the range defined by the temperature high and low limits: The effective slab temperature equals the average of both temperature values.

3. One sensor value outside of the range defined by the temperature high and low limits and the other sensor value within this range: The effective slab temperature equals the temperature value within the range.
4. One sensor value above the range defined by the temperature high and low limits and the other sensor value below this range: The effective slab temperature will be displayed as “-!” to indicate an installation or configuration problem (slab heating will not be activated).

By applying these rules to determine the slab temperature, the moisture detection cycle will be activated at the earliest possible point in time.

#### **4. Idle mode**

The operating mode “On, Idle Mode enabled” requires a combined temperature and moisture sensor (slab sensor) to be connected to sensor port T1 & M1 of the detector and an outdoor temperature sensor (150004) to be connected to sensor port T2 (terminals 6 & 7) of the detector. Additionally, the controller must be configured appropriately for these sensor types.

While in this operating mode, the slab temperature as measured by the sensor connected to port T1 will be controlled to maintain the desired setpoint (within a deadband of  $\pm 2^{\circ}$  F) and the slab heating will be activated accordingly as long as the outdoor temperature as measured by the sensor connected to port T2 is below the temperature high limit (with a deadband of  $\pm 1^{\circ}$  F). Additionally, the moisture detection cycle will be performed periodically. If moisture is detected the slab heating will be operated at full power. Once the sensor ceases to detect moisture the detector will return to maintaining the slab temperature at the desired setpoint as long as the outdoor temperature is below the temperature high limit (WWSD).

#### **5. Emergency operation (not available in “Idle Mode”)**

If two sensors are connected the detector will go into emergency operation mode if one of the two temperature or moisture sensor loops is faulty and this faulty function is activated for both sensors. In this case, only one sensor loop will be evaluated, and this special condition will be indicated by an alternating red and green flashing of the operating state LED light.

#### **6. Moisture value and moisture limit adjustment**

The moisture value as detected by the sensors is a dimensionless number within a range from 5 to 95 where 5 corresponds to a dry sensor and 95 corresponds to a flooded sensor. The value 50 is equivalent to an amount of moisture which is detected under normal operating conditions.

The moisture limit adjustment is used to define the moisture value above which the system detects the presence of moisture. Example: if this limit value is set to 40 any measured moisture value above 40 causes the system to determine that moisture is present. When adjusting the moisture limit value please note that the effect of this value changes progressively with an increasing deviation from the mid-value 50. That implies that a change of the limit value from 20 to 10 or from 80 to 90 results in a change of the detected amount of moisture which is much higher than the one caused by a limit value change from 50 to 40 or 60.

To determine and adjust the best moisture limit value for a given installation, the menu “Sensor Test” can be used. This menu allows to start a moisture detection cycle independent of the rest of the system and to read the resulting moisture value. The test can be performed in a typical situation (with moisture and temperature conditions of the sensor which would justify the heating operation) or by applying an appropriate amount of water to the sensor. In the second case, please ensure that the ambient temperature is within a range typical for winter operation (i.e. not in excess of  $\sim 40^{\circ}$  F /  $\sim 5^{\circ}$  C); above this temperature the moisture value determined by the sensor might possibly deviate from the value found under real operating conditions.

The moisture value resulting from the test can be used to set the moisture limit value of the system (Quick Start menu) or of the individual sensor (Configuration menu).

#### **7. Functional Tests**

**Attention:** When performing tests using simulated temperatures to verify the functionality of the detector the system timing must be taken into consideration. Due to the operating principle of the moisture sensors, these sensors will not allow ambient temperature measurements for approximately 5 to 15 minutes (inhibit time) and subsequent moisture detection cycles for approximately 10 to 25 minutes after the completion of a moisture detection cycle, depending on the sensor type. The timing is designed to meet these conditions and is optimized for the comparatively slow slab and air temperature changes in a real environment. If rapid temperature changes occur in a test environment this may temporarily result in an unpredictable system reaction.

## **16. Error Codes**

In case of a failure, the menu “Show Status” will display an error code for the detector or the sensor(s). The value “0” indicates that currently there is no error. The error codes are explained in the following tables. If more than one error condition is active at any one time the display will show the sum of the related error codes (e.g. error 1 and error 4 active at the same time will cause an error code 5 to be displayed).

## Detector error codes

Error code	Description
1	Slab / gutter temperature cannot be determined; each active temperature sensor reports temperature measurement failure. Potential cause: <ul style="list-style-type: none"> <li>• See Sensor error code 1 (slab / gutter sensors only)</li> <li>• Detector internal failure.</li> </ul>
2	Outdoor temperature required but not available (Idle Mode only); outdoor temperature sensor reports temperature measurement failure. Potential cause: <ul style="list-style-type: none"> <li>• See Sensor error code 1 (outdoor air temperature sensor only)</li> <li>• Detector internal failure.</li> </ul>
4	Moisture cannot be determined; each active moisture sensor reports temperature measurement and / or moisture detection failure. Potential cause: <ul style="list-style-type: none"> <li>• See Sensor error codes 2 or 4, respectively.</li> <li>• Temperature loop of affected sensor faulty.</li> <li>• Detector internal failure.</li> </ul>
8	Configuration problem. Potential cause: <ul style="list-style-type: none"> <li>• No sensor defined for temperature measurement.</li> <li>• No sensor defined for moisture detection.</li> <li>• Idle Mode enabled but no valid sensor defined for outdoor air temperature measurement.</li> </ul>
<p><b>Note:</b> As long as a single sensor failure does not cause the entire ice and snow detection system to fail it will not be shown as a system error using one of the error codes. In this case please check the error codes of the individual sensors.</p>	

## Sensor error codes

Error code	Description
1	Temperature sensor faulty. Potential cause: <ul style="list-style-type: none"> <li>• Sensor cable damaged (open loop or short circuit).</li> <li>• Temperature detector inside the sensor faulty.</li> <li>• Detector internal failure.</li> </ul>
2	Supply voltage prior to start of the last moisture detection cycle not within the defined voltage range; detection cycle has not been started. Potential cause: <ul style="list-style-type: none"> <li>• Detector supply voltage more than + 10 % above rated voltage.</li> <li>• Detector supply voltage less than - 15 % below rated voltage.</li> <li>• Detector internal failure.</li> </ul>
4	Most recent moisture detection faulty. Potential cause: <ul style="list-style-type: none"> <li>• Supply voltage too low during last moisture detection cycle</li> <li>• Sensor cable damaged (open loop or short circuit)</li> <li>• Moisture detector inside the sensor faulty</li> <li>• Detector internal failure</li> </ul>
8	Internal failure during most recent moisture detection. Potential cause: <ul style="list-style-type: none"> <li>• Configuration problem</li> <li>• Detector internal failure.</li> </ul>
<p><b>Note:</b> The sensor error codes 2, 4 and 8 will only be set during a moisture detection cycle and will remain visible at least until the completion of the next moisture detection cycle of the affected sensor. This will even apply if no more moisture detection cycles are started due to the slab / gutter temperature leaving the active window. To reset the error code after fixing the problem manually start a detection cycle from the test menu (Test &gt; Sensor Test x).</p>	



## 17. Serial interface

A PC may be connected to the ice and snow detector through the serial interface, using an optional data cable. The *Ice Monitor* software application will allow reading and analyzing all parameters, measured variables and operating states. Optionally, the measured variables can be recorded as time-stamped values in a log file as long as the PC remains connected. The log data can be evaluated using a standard spreadsheet software package.

## 18. Supported sensor types

The 605100A Detector allows selecting the following sensor types:

- Gutter sensor 605030 (default measurement method: T+M)
- Slab sensor 605020 & 605050 series (default measurement method: T+M)
- Outdoor Air Temperature sensor 150004 (no moisture detection; default measurement method: T)

Sensor type	Model	Description
	605030	Gutter Sensor with 20' cable. For use with 605100A detector only.
	605020A	Slab Sensor with 65' cable includes brass holding sleeve for new installations. For use with 605100A detector only.
	605050A	Slab Sensor with 165' cable includes brass holding sleeve for new installations. For use with 605100A detector only.
	605020R	Slab Sensor with 65' cable includes brass adaptor ring to fit larger old style holding sleeve. For use with 605100A detector only.
	605050R	Slab Sensor with 165' cable includes brass adaptor ring to fit larger old style holding sleeve. For use with 605100A detector only.
	150004	Outdoor Air Temperature Sensor to use for idling mode with 605100A detector

## 19. Detector enclosure mounting

The enclosure consists of a socket and housing for the electronics which is plugged onto the socket and secured with a center cover screw.

### Dimensional drawing

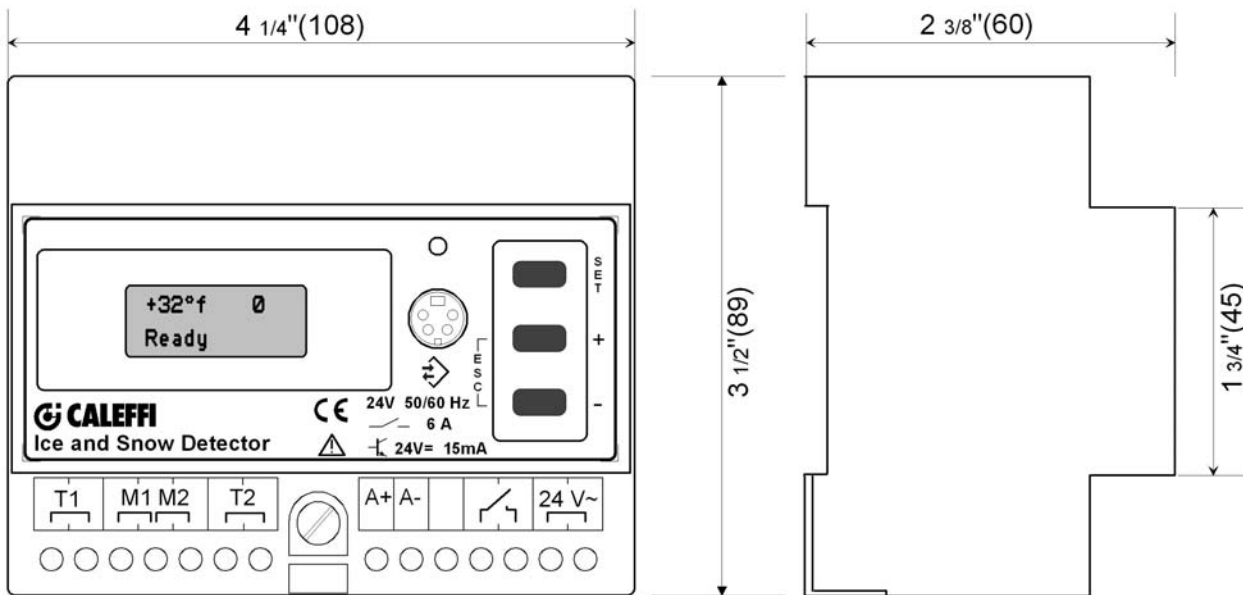

### Mounting the detector enclosure

Detector enclosure mounting is recommended. Loosen the center screw on the face of the enclosure; gently pull down and out to separate the socket base (back) from the electronics module (front). Wire detector socket (See "Wiring diagrams". After wiring: line up terminal pins with the correct sockets on the terminal blocks. Push gently until the cover snaps into place. Tighten the center cover screw.

## 20. Detector wiring installation



**Warning:** Electrical shock hazard. To prevent electrical shock or equipment damage, disconnect **ALL** power sources to detector and loads before installing or servicing this equipment or modifying any wiring.

### 1. Connecting output relay

Connect wires from the terminals of the isolated form A (SPST) normally open relay contact to the digital input of heating system. Max. Load 24 V~, 6A, dry contact.

### 2. Connecting alarm output

Connect wires from the Alarm + and Alarm - terminals to any compatible forwarding alarm device. Voltage output 24 V= ± 20%. Max. Load 15 mA, short circuit protected

### 3. Connecting power

Connect the wiring from the 24 VAC transformer to the terminals marked 24V~. A 24 VAC Class II transformer must be used with a minimum 20VA rating. Acceptable voltage range: 24 VAC +10/-14%. Do not connect either of the transformer secondary wires to ground.

#### 4. Connecting one Slab sensor or one Gutter sensor

Connect the temperature wires (brown) and (blue) to terminals T1. Connect the moisture wire (red) to terminal M1 and (red/black) to terminal marked M1/M2.

Wiring diagram for 1-sensor

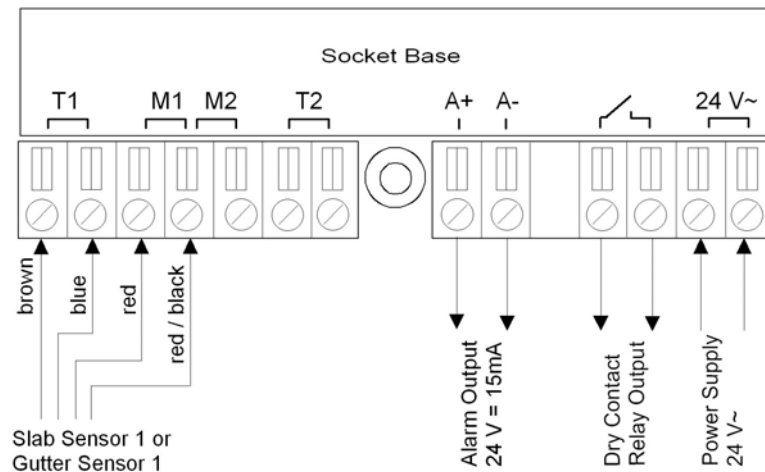

#### 5. Connecting two Slab sensors or two Gutter sensor

Connect the first sensor's temperature wires (brown) and (blue) to terminals T1. Connect the moisture wire (red) to terminal M1 and (red/black) to terminal marked M1/M2. Connect the second sensor's temperature wires (brown) and (blue) to terminals T2. Connect the second sensor's moisture wire (red) to terminal M2 and (red/black) to terminal marked M1/M2.

Wiring diagram for 2-sensors

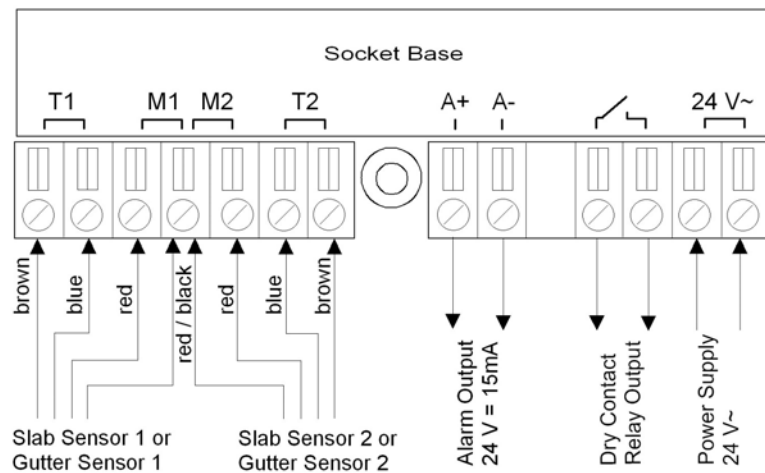

**6. Connecting one Slab sensor and Out Door Air sensor (required when implementing idling mode)**

Connect the slab sensor's temperature wires (brown) and (blue) to terminals T1. Connect the moisture wire (red) to terminal M1 and (red/black) to terminal marked M1/M2. Connect the OAT (outdoor air temperature) sensor model 150004 wires to terminals T2.

Wiring diagram for 1-Slab sensor and OAT sensor

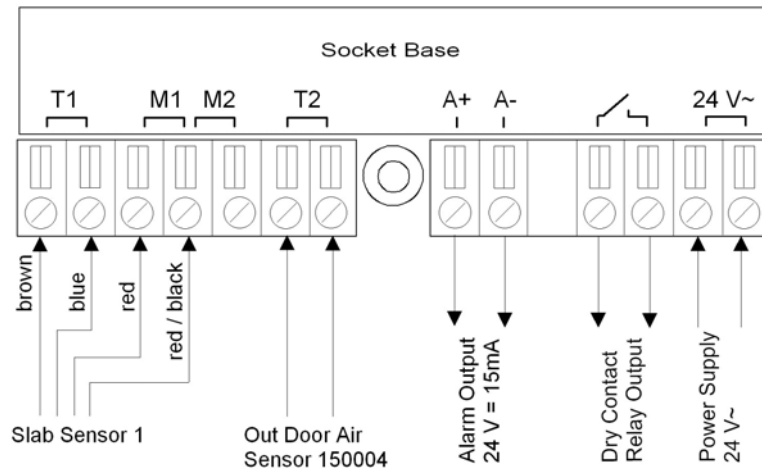

Caleffi North America, Inc.  
9850 South 54<sup>th</sup> Street,  
Milwaukee, WI 53132  
Tel: 414.421.1000 Tel: 414.421.2878